

Summer 2014

\$9.00 USD

# Finer Points

**SUPERABRASIVE INDUSTRY REVIEW**

**IMTS Preview**

## THIS ISSUE

**IDA 2014 Annual Meeting Overview**

**Dart Masters the "Peaks and Valleys" of Custom Engine Block Production with Advanced Flexible Diamond Honing System**

**INTERTECH 2015 Announcement**

**In Memoriam of E. Louis "Lou" Kapernaros**

**IDA Education Course Announcement**

**Gehring Technologies GmbH Honing of Gears**

**What You Need To Know About Social Media Etiquette**

**US Manufacturers Reboot: Three Initiatives for Success**

**THE LONGEST RUNNING MAGAZINE DEDICATED SOLELY TO THE TECHNOLOGY AND APPLICATION OF SUPERABRASIVES**



# ZHONGNAN DIAMOND CO., LTD

... A GLOBAL MANUFACTURING FORCE

The largest manufacturer of synthetic diamond in China and one of the largest manufacturers of industrial diamond in the world.



®

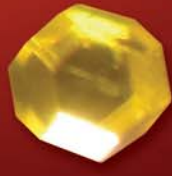
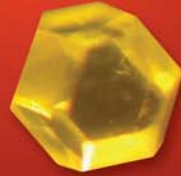
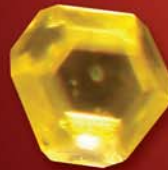
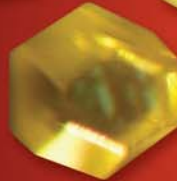
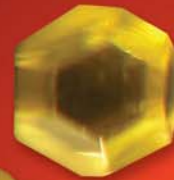
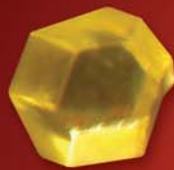
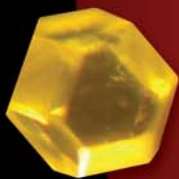

## The Company Features:

### TREMENDOUS CAPACITY

- Production facility with 2.4 Million Square meters (26 million square feet) of factory space
- Annual output of high-grade synthetic diamond and Cubic Boron Nitride (CBN) can be up to 6 billion carats
- More than 3000 highly skilled employees

### STATE OF THE ART RESEARCH & DEVELOPMENT CENTER

- Providing High Quality, Innovation and New Technology

### AN INTERNATIONAL SALES NETWORK

- Guarantees outstanding customer service and support at competitive prices

### ADVANCED TESTING EQUIPMENT TO CONTROL QUALITY AND CONSISTENCY

- Superior crystal shape, diaphaneity, compact strength and thermal stability

### COMMITMENT TO THE ENVIRONMENT

- Recycling up to 95% of production materials
- Waste water recycled 100%

### AWARD WINNING OPERATIONS

- ISO 9001:2000
- China Top Brand
- High-Tech Enterprise Certification
- China Brand Award For International Market Innovation
- Certificate Of Conformity Of Quality System



**Contact Us Today And Join The Growing International List Of Satisfied Zhongnan Diamond Customers...**

### US OFFICE

American Zhong Nan Inc.  
17890 Castleton Street, Suite# 108  
City of Industry, CA 91748 USA  
Telephone: 626-839-2886  
Fax: 626-839-0887  
Email: chimayinc@hotmail.com  
Website: www.diamond-zn.com

### CHINA HEADQUARTERS

Zhongnan Diamond Co., Ltd.  
P.O. Box 101  
Fangcheng, Henan China 473264  
Telephone: +86-377-67319259, 67319306  
Fax: +86-377-67319212, 67318220  
Website: www.diamond-zn.com



# Finer Points



## feature articles

- 5** IDA 2014 Annual Meeting Overview
- 10** Dart Masters the “Peaks and Valleys” of Custom Engine Block Production with Advanced Flexible Diamond Honing System
- 14** INTERTECH 2015 Announcement
- 16** In Memoriam of E. Louis “Lou” Kapernaros
- 19** IDA Education Course Announcement
- 20** Gehring Technologies GmbH Honing of Gears
- 27** What You Need To Know About Social Media Etiquette
- 28** US Manufacturers Reboot: Three Initiatives for Success

## departments

- 4** A Finer Point of View
- 6** Editorial
- 8** News & Notes and New Products
- 12** IDA Member Companies
- 16** Calendar of Events
- 17** Ad Insertion Order Form
- 30** Checklist of Things to Do ...

### COVER PHOTO

Photo Courtesy of Gehring Technologies GmbH showing Machining station setup for honing gears.

**FINER POINTS** is the longest running publication devoted exclusively to the understanding, selection and application of diamond, cubic boron nitride and related materials. It is edited for recipients who are involved in some way with these “superabrasives”, either as providers of the materials, producers of products containing the materials or users of these products (e.g., grinding wheels, dressing tools, drill bits, saw blades, sawing wires, cutting tools, polishing compounds, CVD film products, etc.).



## advertisers

ABC Warren Superabrasives Saint-Gobain Surface Conditioning Group .....	11
Apogee Precision Parts .....	18
Bogimac NV-SA .....	6
Crystallume Engineered Diamond Products .....	9
DCM-TECH, Inc. ....	26
Element Six .....	OBC
Engis Corporation .....	23
ILJIN USA, Inc. ....	13
Lands Superabrasives .....	7
Niabrazo .....	25
Radiac Abrasives .....	24
Ulbrich Stainless Steels and Special Metals, Inc. ....	21
Worldwide Superabrasives, LLC.....	IBC
Zhongnan Diamond Co., Ltd. ....	IFC

# A Finer Point of View...

We are living in a time of unprecedented change. The "Great Recession" of 2008/2009 was like nothing we have ever seen in our lifetimes, perhaps ever. The "Jobless Recovery" since 2010 has created a landscape of new expectations, automation, social media, rapid customization, opportunities and competition. The industries that can adapt to this new world will be the industries that will exist and be viable into the future. The IDA's mission is to help ensure that the Superabrasives Industry is one of those industries that will continue to thrive.

Over the past three years, the Board of Directors for the IDA has established and is executing a strategic plan to live the Mission of the IDA. That Mission of the IDA is to facilitate growth of the Superabrasives Industry through promotion and education on the use, application and development of superabrasives in the North America Market.

Beginning with INTERTECH 2013, this bi-annual technical conference has had a central theme based on the economic base surroundings of the host location. Baltimore gave INTERTECH the opportunity to attract an audience from the Aerospace and Defense Industries in that region of the US. These industries were the focus of the conference while, in addition, developments and advancements within other core markets that use superabrasives, like Automotive, Concrete, Oil and Gas and others, were also well represented. In 2015, Indianapolis gives the IDA the opportunity to attract experts, leaders and academia that work in the Automotive and Medical Implant Industries. As a result, the intent is to feature applications and development from these industries as the central theme of INTERTECH 2015, supported by advances in superabrasives from other industries as well.

Based on the results of 2013, the Board of Directors believes this subtle change of direct for INTERTECH will enhance the "promotion" leg of our Mission Statement by attracting more people from the local region in which INTERTECH is hosted.



**PRESIDENT**  
Troy Heuermann

In November 2014, the IDA is hosting an Educational Workshop in Huntsville, AL. This workshop was a part of the INTERTECH Conferences in 2011 and 2013. This will be the first time this workshop will be held at a separate venue as a stand-alone event. The goal of the workshop is provide a basic level of information and content for anyone involved in the use, development or sales of superabrasives. We believe this basic understanding will provide the awareness needed by engineers, plant managers, operators and Industrial Distribution to increase the growth of superabrasives as an alternative to other tools and applications.

As the world continues to get smaller and the pace of change continues to increase, adapting and changing is the key to long term viability. With social media and the internet, access to new developments and information has never been easier or faster. However, the information on your smart phone at times can be less reliable depending on the source. The Mission of the IDA is clear. Our goal as an Association is to bring that Mission to life in a trustworthy and reliable way for our members.

Sincerely,

Troy Heuermann  
Industrial Diamond Association of America



Industrial Diamond  
Association of  
America, Inc.

## **PRESIDENT**

Troy Heuermann  
3M Abrasive Systems Division

## **VICE PRESIDENT**

Keith Reckling  
National Research Company

## **SECRETARY/TREASURER**

Benjamin B. Williams  
FACT USA

## **PAST PRESIDENT**

Mike Mustin  
American Superabrasives Corporation

## **BOARD OF DIRECTORS (term)**

Ed Francis (13-15)  
Crystallume Engineered Diamond  
Products

Matt Collier (14-16)  
Vollmer of America Corporation

Stephen Griffin (14-16)  
Engis Corporation

David Spelbrink (14-16)  
Lieber & Solow, Company

Scott Ries (13-15)  
Vollmer of America Corporation

David Simpson (13-15)  
Worldwide Superabrasives

Shane Hollenbaugh (14-16)  
YG-1 USA

## **EXECUTIVE DIRECTOR**

Mr. Terry M. Kane  
Industrial Diamond Association  
of America, Inc.  
P.O. Box 29460  
Columbus, Ohio 43229  
Phone: 614-797-2265  
FAX: 614-797-2264

E-Mail: [tkane-ida@insight.rr.com](mailto:tkane-ida@insight.rr.com)

Website: [www.superabrasives.org](http://www.superabrasives.org)

FINER POINTS is the official publication of the Industrial Diamond Association of America, Inc. and is published four times a year. Contributions are welcomed but the Editor reserves the right to accept or reject any material deemed inappropriate for publication. All by-lined articles published in this magazine represent solely the individual opinions of the writers and not necessarily those of the Industrial Diamond Association. Executive and Editorial Offices: Finer Points, P.O. Box 29460, Columbus, Ohio 43229. (614) 797-2265. Editor and Advertising, Terry Kane. Advertising rates and deadlines available upon request. Copyright 2002. Material in FINER POINTS may not be reproduced in any form without express written consent.

ISSN: 1090-0896

# INDUSTRIAL DIAMOND ASSOCIATION OF AMERICA 2014 Annual Meeting OVERVIEW

The IDA Annual Meeting was held May 12, 13 & 14 in Indianapolis, Indiana. This meeting was very successful and most attendees said it was one of the best they had ever attended. The IDA welcomed four new members this year, Cutting Edge Services, HK Technologies, Mapal, Inc and YG-1 USA. The business reports showed the IDA in excellent shape both from a financial standpoint and with ongoing programs to help IDA Members. The membership was very impressed with the long list of projects that their Board had accomplished over the past year. Of course the successful INTERTECH 2013 stood out as the key program. There were lively discussions regarding advertising and promotional agendas and exceptional working sessions regarding preparations for INTERTECH 2015 and the upcoming Educational Courses. General details were finalized for both of these important events. This is the one time each year when the IDA Membership has the opportunity to meet face to face with their Board of Directors and this year was especially active with many suggestions and recommendations from everything about Finer Points content and advertising rates to ideas on locations for meeting and technical conferences. Many members commented this was one of the best meetings with member interaction they had ever seen. In addition to the solid business meeting the Annual Meeting also had outstanding technical and business presentations presented by Pramod Gupta, Principal of A.T. Kearney, Inc., Jeremy Cardellino, A Graduate Research Associate at The Ohio State University Physics Department and William A. Strauss, Senior Economist and Economic Advisor at the Federal Reserve Bank of Chicago. Mr. Gupta gave an excellent presentation on the reshoring issue, pointing out issues on whether companies have the motivation to reshore or the limiting factors that would keep this out of consideration. Jeremy Cardellino spoke about the new technology being developed to increase the capacity and volume of information that could be transmitted through a diamond wire ... quite a compelling presentation. Then we closed with an excellent presentation and financial analysis regarding the economy and the manufacturing sector delivered by William Strauss. William is well known throughout the industry for his keen sense of timing and accurate financial forecasts. Outgoing President Mike Mustin presented the President's Award to Kathy & Terry Kane for their outstanding leadership and dedication over the years managing the Industrial Diamond Association of America and its programs.



**THE 2014 BOARD OF DIRECTORS (ABOVE) WERE ANNOUNCED AND INTRODUCED AT THE ANNUAL BANQUET.** From left to right: **MIKE MUSTIN** – Past President American Superabrasives Corp., **BEN WILLIAMS** – Director FACT USA, **TERRY KANE** – Executive Director IDA of America, **TROY HEUERMANN** – President 3M Abrasives Div., **SCOTT RIES** – Director Vollmer Of America, **MATT COLLIER** – Director Element Six, **SHANE HOLLENBAUGH** – Director YG-1 USA, **KEITH RECKLING** – Vice President National Research Co., **DAVE SIMPSON** – Director Worldwide Superabrasives, **STEPHEN GRIFFIN** – Director Engis Corp. Not pictured **DAVID SPELBRINK** – Director Lieber & Solow Co. and **ED FRANCIS** – Director Crystallume Engineered Diamond.



**TERRY KANE, Editor**

## IMTS - A TRANSITION TO TECHNOLOGY

The biennial IMTS is coming to Chicago this September and as always it will showcase some of the leading new manufacturing developments from around the world. Those of us who have been in the industry for a while remember when IMTS stood for International Machine Tool Show. Back then machines were the only focus of the

show and each pavilion was rich with small machines and large and the aroma of coolant and oils drifting across the floor. The sights and sounds were a staccato of images and metallic timbre playing across our senses. In the 1960's, with the computer revolution in its early stages, numerical control was a hot topic and little did we know how that would evolve into the software and digital age. I remember my first experience at IMTS in the early 70's as a young technician demonstrating a new abrasive called cubic boron nitride (cBN). The machine we had was an old K.O. Lee end mill grinder with an air bearing. Hour after hour we took turns sharpening the high speed steel tool by drawing the end mill across the face of the grinding wheel. Visitors watched in awe as that new abrasive sharpened that end mill with a cool grind and no dust or burn. Of course today the world is well aware of cBN and the performance advantages of that superabrasive. But cubic boron nitride wasn't the only new product or development introduced or promoted at IMTS over the years. The new technology that complimented the machines and made for manufacturing innovations was not just abrasives but those aforementioned computers, automated systems, higher speeds, and machining centers just to name a few. Grinding machines that once labored with silicon carbide or aluminum oxide wheels, or turning and milling machines with carbide or high speed steel inserts have gone by the wayside in preference for CNC Grinding Machines that provide superior material grinding teamed with the operational flexibility of standard milling, drilling, tapping, and boring. These machine centers are especially designed to take full advantage of diamond, cBN, CVD diamond or polycrystalline "superabrasives"! All these technological developments led to an entire change in focus for IMTS and by 1990 the official name of the show was changed to the International Manufacturing Technology Show, reflecting the changing industry and the broader scope of exhibits. If you are a returning visitor or a first time attendee, IMTS will be the place to explore and gain information about how to improve your manufacturing operation... See you there!



INTERNATIONAL MANUFACTURING TECHNOLOGY SHOW  
September 8 - 13, 2014 | McCormick Place | Chicago



Ansi B74.23  
**FRIATESTER**  
for diamond & CBN  
superabrasives

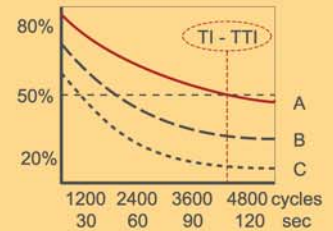

reliable results  
low deviation  
longterm stability



back-lash free mechanics  
microcontrolled precision  
impact quality monitor  
quick-clip capsule loading  
horizontal or vertical  
easy operation & safety



[www.bogimac.com](http://www.bogimac.com)

bogimac engineering nv-sa info@bogimac.com  
Brusselsesteenweg 107, BE-1850 Grimbergen



*When selecting diamonds...  
sometimes trusting your  
eyes alone isn't enough.*

LANDS Superabrasives: Natural, Synthetic and Polycrystalline Diamond and CBN products.

- Thermal Stability
- Friability
- Image Analysis
- Single Crystal Crushing Test
- Impact Resistance
- SEM
- Surface Morphology
- EDX
- Laser Diffraction
- Shape Characterization
- Specific Gravity
- Size Analysis
- Color Index
- Metallurgical Sample Preparation



LANDS Superabrasives, Co. New York, NY USA  
888-335-7600

Premier Diamond Corp. Antwerp, Belgium  
+32 3 225 25 11

[www.landssuperabrasives.com](http://www.landssuperabrasives.com)

# NEWS & notes

With NEW PRODUCTS



**WWSA**  
Worldwide Solids

WORLDWIDE SOLIDS, LLC A  
DIVISION OF WORLDWIDE

**SUPERABRASIVES, LLC (WWSA), A GLOBAL LEADING MANUFACTURER OF INDUSTRIAL DIAMONDS AND CBN MATERIALS, IS EXCITED TO ANNOUNCE THE HIRING OF AARON NOLAN AS THE NEW SOLIDS PRODUCTS MANAGER.**

Aaron brings 9 years of superabrasive experience to WWSA's Team of Chris Winkel, Dave Simpson, Dan Herzog and John Chalvadakis. Prior to joining WWSA Aaron was Regional Sales Manager for Mitsui Seiki USA. Prior to his time at Mitsui Seiki Aaron worked for Sumitomo Electric Carbide Materials Group for 8 years. During that time he was responsible for PCD/PCBN cutting tools, PCD wire die blanks, specialty carbide materials, single crystal HPHT diamonds throughout North America. He was an involved member of the IDA as a Board of Director as well as a WAI Ohio Valley Board of Director. Aaron attended Capital University in Columbus, OH earning degrees in Economics and Mathematics. Aaron's knowledge of the superabrasive and cutting tool market will be a great addition to The WWSA Group.

## ELEMENT SIX SUPPORTS 65TH DIAMOND CONFERENCE AT WARWICK UNIVERSITY

The conference was established by De Beers in July 1949, with the event quickly becoming recognised as a leading annual forum bringing together diamond experts from academic, scientific, industrial and technology fields. Over the course of 65 years the event has contributed to advancing the knowledge of natural and synthetic diamond. Industrial-related diamond themes at previous events have covered subjects including diamond synthesis and defects, and impurities in diamond which subsequently advanced the wider industry's knowledge of the extreme performance capabilities of synthetic diamond for industrial purposes. Element Six, one of the world's leading producers of synthetic diamond for industrial and technology-related applications presented three technical papers at the event, featuring high temperature and high pressure growth of isotopically-enriched diamond, novel polycrystalline cubic boron nitride materials and engineering the properties of synthetic diamond cutting tools.

elementsix™



## MEET THE KEY PLAYERS IN METAL CUTTING

Intricate part designs and exotic new materials make identifying the proper machining technique more important than ever before. Tolerances have tightened, and we learn more as an industry with each passing year about the effect the machining method has on the quality of the finished product. In response, OEMs are hard at work designing machines that will meet these challenges while at the same time setting them apart from their competitors. As a result, automation, palletizers and tailored cell configurations have revolutionized the metalworking industry. Visit the Metal Cutting Pavilion in the South Building to see the names you already know and to learn about those you'll need to be aware of tomorrow.



## BOEING ROLLS OUT 5000TH NEXT-GENERATION 737 MODIFIED 737-700C TO BE DELIVERED TO U.S. NAVY

The airplane is a Boeing C-40A Clipper, a modified 737-700C, that will serve as a transport aircraft for the U.S. Navy. "This milestone is another testament to the popularity of our Next-Generation 737 and represents the confidence our customers have in the work of our team," said Beverly Wyse, vice president and general manager, 737 program, Boeing Commercial Airplanes. "The 737 is hugely popular with both our commercial and military customers because of its efficiency and proven reliability." Utilizing the 737 commercial platform takes advantage of the proven efficiencies, manufacturing processes and performance of the existing Next-Generation 737 production system. Boeing's P-8 maritime patrol aircraft, Airborne Early Warning and Control (AEW&C) and the C-40 are among the 737 military derivatives. "The quality and dependability of these aircraft are directly linked not simply to their design, but to the hardworking men and women who build them," said Vice Admiral Robin Braun, chief of Navy Reserve and commander, U.S. Navy Reserve Force. To date, orders stand at 6,804 for Next-Generation 737s and 2,109 for 737 MAXs. Total 737 orders have surpassed 12,000 including Classics and more than 100 orders for military derivatives. "With more than 280 different customers, it's easy to see why the 737 is the best-selling airplane in the world," said Wyse. Contact: Dina Weiss, 737 Communications Boeing Commercial Airplanes 206-853-9620 dina.m.weiss@boeing.com





TAKE ADVANTAGE OF VOLLMER MID-YEAR SPECIALS!



**VOLLMER CL200 Benefits:**

- Blade Outside Diameters of 80mm- 840mm
- Highly Flexible Use of Grinding Wheels
- Saw Blade Support with Height Adjustment
- High Grinding Wheel Clearance
- Integrated Measuring Probe
- Auto-detection of New Teeth & Broken Teeth

**VOLLMER AS810 Benefits:**

- Blade Outside Diameters of 100mm-810mm
- Feed Cams for Variety of Machining Needs
- Up to 25 degree Backing of Angle
- Tooth Pitch 7mm-100mm
- Electronic-Hydraulic control
- Machining in a Single Pass



This is limited to the two machines specified and is on a first come, first serve basis. Call our office today for more information 412-278-0655.



**FIVES GIDDINGS & LEWIS ADDS OFF-CENTERLINE MILLING, DRILLING, TAPPING CAPABILITIES TO VTCS WITH NEW Y-AXIS ATTACHMENT**

that combines a C-axis head with table and X and Z-axis motions. The attachment, available fully integrated on new VTCs or as a retrofit, allows for single-setup processing of flanged parts, pumps, compressors, motor housings, fluid routing parts, intakes and exhausts, among others. The Y-axis attachment will be featured in the Fives booth at IMTS (N-7018), and live cutting demonstrations will be part of the Fives Giddings & Lewis bus trip tours during the show. "The Y-axis attachment is a powerful package, with a wide range of motion," said Pete Beyer, Director of Product Strategy and Development at Fives Giddings & Lewis. "Its power and torque are equal to our standard, heavy-duty right-angle heads, with no limits in cutting performance relative to speed. This is an affordable way to reduce setups and free up machine time on horizontal machining centers and boring mills that used to be required to produce these same features on turned parts." The C-axis head provides  $\pm 45$  degrees rotation, creating a machining range of Y-axis features of  $\pm$  the VTC table radius. The continuous power 22-kW (29-hp) attachment has a maximum spindle speed of 2200 rpm, and continuous torque of 875 Nm (645 ft-lb), and can be loaded manually or automatically via the machine's automatic toolchanger. A live spindle accommodates standard Kennametal KM80™ or Sandvik Coromant® Capto C8 tooling. Coolant delivery via external nozzles on the face of the attachment or thru-the-spindle coolant is provided. The preloaded, high-efficiency, C-axis drive and highstiffness roller bearings ensure accuracy. The attachment's integrated measurement system allows for accurate machining of part features. For additional information, see: [www.fivesgroup.com](http://www.fivesgroup.com)



fives

# CRYSTALLUME CVD DIAMOND

**Crystallume has been Manufacturing CVD Diamond since 1984 with Nine CVD Production Systems Available**

- Diamond on Tungsten Carbide
- Diamond on Silicon
- Diamond on GaN
- Diamond on Silicon Carbide
- Diamond on Graphite
- Free Standing Diamond
- Complex Geometries
- SEM and TC Analysis In-house

**Crystallume**

ENGINEERED DIAMOND PRODUCTS

3397 De La Cruz Boulevard  
 Santa Clara, CA 95054 USA  
 Phone: +1 408 653-1700  
 Fax: +1 408 653-1710  
[www.crystallume.com](http://www.crystallume.com)

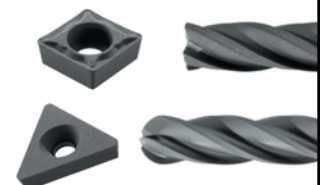

See Us at  
**IMTS**  
 Booth 2206

# DART MASTERS THE "PEAKS AND VALLEYS" OF CUSTOM ENGINE BLOCK PRODUCTION WITH ADVANCED FLEXIBLE DIAMOND HONING SYSTEM

**American-made Sunnen SV-20 honing system uses programmable control to replicate "best" engine parameters and produce expert results with minimal operator expertise.**

By RAY KEMBLE  
Kemble & Drum Communications Inc.

For a business to thrive, it must be able to negotiate the inevitable economic peaks and valleys. A world leader in manufacturing engine blocks for racing and high performance enthusiasts – as well as replacement blocks for a variety of Detroit V-8 engines – Dart Machinery uses its mastery of peaks and valleys, specifically in honing cylinder bores, to produce custom results with near-mass-production efficiency. Advanced honing provides a key differentiator for maintaining a competitive advantage and achieving greater efficiencies and flexibility in processing an ever-changing mix of blocks, says Dick Maskin, Dart founder and president.

A new honing system from Sunnen Products enables high-precision, highly-flexible honing of a wide range of block designs and metallurgies in a single continuous process without the need for stone change, he reports. American-made in St. Louis, the SV-20 replaces a more expensive, European-built honing system that "just wasn't a good fit for our production, not flexible enough," says Maskin.

Maskin started Dart in 1981 in a two-car garage in Oak Park, a Detroit suburb, and has grown it into the manufacturing leader in racing and high-performance engine blocks, heads and other components. The company does its part to keep Detroit "Motor City" with both a technology center and manufacturing facility located in the metro area. Today 95 Dart employees make about 8,000 blocks and 16,000 heads a year for drag racing, circle track racing, road racing, and highperformance custom cars, as well as marine and industrial power applications.

"We produce custom in volume," states Maskin. Blocks are manufactured to customer order in type and material, bore spacing, cam location, bolt pattern, deck height, lifter location, oil pan bolt pattern, metric or U.S. dimensions – "just infinite variation and specialization," he says. Dart makes blocks in various grades of iron (cast to CGI) and in aluminum with iron-sleeved cylinder bores, including blocks machined from forged and heat-treated aluminum billets. The manufacturing facility operates three shifts, 6 or 7 days a week depending on production volume, with 26 large Makino CNC machining centers churning out blocks, heads and manifolds. Customers can choose between seven different base block designs covering big block and small block sizes, all evolved from NHRA pro stock V-8 experience. "That's where all the technology comes from," says Maskin, whose own engine creations achieved drag-racing's first 300 mph quarter-mile run and four-second Funny Car elapsed time.

Applying that creativity to honing, Dart combines two advanced technologies – diamond honing abrasives driven with a programmable spindle, followed by profilometers to measure the peaks and valleys of cylinder surface finishes – to replicate "best" block finishes and ring seal. "Experienced racers have always had their favorite blocks, ones that ran better than others," notes Maskin. "We've learned through experience that it was not the block that made the difference, but how your honing process worked for that exact block, while similar blocks might produce much less horsepower. Once you understand the finish you need from honing – and we know these numbers now thanks to profilometers – you can make the bad blocks good, too. We use honing to achieve the ideal Rvk (valley depth average), Rpk (peak height average), Rk (core roughness depth), and crosshatch to finish a block for a given application."

Knowing the desired result, the honing process can be tweaked to achieve the result in any block, he says. "If you go from a 200 brinell block of cast iron to a much tougher CGI (compacted graphite iron) block, you need to know how to achieve your finish numbers in the different materials," says Maskin. "Finishes also must account for the type of fuel burned in the engine, which could be alcohol or natural gas." This honing system gives Dart the flexibility to efficiently process any engine block in any material and hardness. "There is no typical production run for us," notes Maskin. "We can put a new block on the machine, once the program is written, and no machine can make a cylinder rounder or straighter," he states. "The finish is all based on programming. If you know where you want to go, you can get there."



**A small block Chevrolet performance block being honed in the new SV-20 machine.**



**Sunnen's two-stage diamond abrasive honing tool does roughing and finishing with 220- and 500-grit abrasive without pause for stone change. The advanced control system on the SV-20 allows Dart to achieve a wide range of finishes with these two abrasives.**



**A ring compressor eliminates pre-compression of the rings and a square installation in the bore.**



**Technician Bob Dimitrijevič installs Darton iron sleeves in cast aluminum block, while a billet aluminum racing block awaits installation. Aluminum block bores are honed for size and geometry before liner installation.**



**A Sunnen CH-100 fixtures a block for manual honing of cam tunnel.**

Computer control has taken much of the black art out of honing, he notes. "Machines like this produce a finish and size that previously required a very talented machinist," says Maskin. "If you have to hone different blocks with different material content, like we do, the newer equipment is significantly better." An advanced true-linear stroking system with 3.36 hp (2.5 kW) servo drive keeps the honing tool concentric with the bore throughout the full stroke length to produce a consistent diameter from top to bottom of the bore. The SV-20 can hone bores with inside diameters from 0.75 to 8 inches (19-200 mm). The machine's work envelope of 36" x 40" (915 mm x 1015 mm), front-loading design, and weight capacity up to 1500 lb (680 kg) combine for exceptional processing versatility.

Dart's business also needs good cycle time, and the high-torque 5.5 hp spindle on the new machine delivers. "With this machine and a new block you can take 6-8 thousandths out in less than a minute," he reports. Two-stage diamond tooling – 150 and 600 grit – performs rough and finish honing without pause for stone change. This combination of stones allows Dart to get almost any surface finish, he says. Other productivity enhancements he notes are automatic size lock, dwell, and real-time bore profile display.

The PLC-controlled SV-20 utilizes an 8-inch industrial color touch screen with hand wheel to jog for fast setup and easy operator training. The computer control ensures automatic, consistent bore-to-bore geometry and finish, without constant adjustment by the operator. The control automatically calculates required spindle/stroker speeds, based on the operator's desired crosshatch angle, or it will display a crosshatch angle based on the operator's inputs for the spindle/stroker speeds. Variable speed control allows a much wider range of processing options and consistent crosshatch pattern, with automatic switching from roughing to finishing at one push of a button.

While the new machine has taken over most day-to-day honing work, an older machine may still find use for certain applications. "We have many Sunnen hone heads going way back, and in special situations our best machinists can do things with them we call 'cheating.'" For more than 30 years Dart has stayed on the leading edge of V-8 performance-block design and manufacture. With the new SV-20, it is honing that edge through superior piston-sealing precision and manufacturing efficiencies. For additional information on the SV-20 vertical honing machine email [sales@sunnen.com](mailto:sales@sunnen.com). ●

AMERICAS • EUROPE • CHINA • JAPAN • KOREA • MALAYSIA • PHILIPPINES • SINGAPORE • TAIWAN • THAILAND



ISO 9001:2008 + ISO 14001:2004-qualitätszertifiziert



**ECO FRIENDLY** ABC Warren Superabrasives is an eco-friendly company

## Precision begins with the Powder

**Superior selection + certified manufacturing  
Single source + global reach**

Precise and consistent sawing, drilling, grinding, lapping and polishing starts with the right diamond powder matched to the exact requirements for each application. The Saint-Gobain Surface Conditioning Group streamlines this process by providing a wide selection of options to cover challenges posed by almost every situation. Mesh product from ABC Superabrasives and Micron powder from Warren Superabrasives cover the particle spectrum from 16/20 mesh (~1000 microns) to 10 nanometers ( $10 \times 10^{-9}$  meters). These powders are produced routinely and consistently in our state-of-the-art facilities. Best-in-class materials are provided to end users ranging from grinding wheel companies to magnetic recording head manufacturers.

Plus, our manufacturing facility in Olyphant, PA, USA is ISO 9001:2008 and ISO 14001:2004 certified, and our new plant in Handan, China is processing mesh diamond and CBN to help ensure optimal capacity and delivery the world over.

**Call us today, or learn more online at [www.abcwarren.com](http://www.abcwarren.com)**

ABC Warren Superabrasives  
Saint-Gobain Surface Conditioning Group  
1401 East Lackawanna Street  
Mid-Valley Industrial Park  
Olyphant, PA 18447 USA  
Tel # 570 383 3261  
Fax # 570 383 3218  
[www.abcwarren.com](http://www.abcwarren.com)  
Email: [abcsuperabrasives@saint-gobain.com](mailto:abcsuperabrasives@saint-gobain.com)



SEE US AT IMTS 2014  
McCormick Place, Chicago, IL  
September 8-13  
North Hall, Booth N-7148

# INDUSTRIAL DIAMOND ASSOCIATION OF AMERICA

## MEMBER COMPANIES



Contact an IDA Member Company for superior products and services related to the superabrasives and ultra-hard materials industry. IDA Members follow a strict code of ethics to guarantee quality and dependability.

**VISIT YOUR IDA MEMBER COMPANY AT IMTS 2014 • Always buy from an IDA Member!**

### 3M Abrasive Systems Division

Website: [www.mmm.com](http://www.mmm.com)

### ABC & Warren/Amplex Superabrasives

Website: [www.saint-gobain.com](http://www.saint-gobain.com)  
VISIT US AT IMTS BOOTH N-7148

### Abrasive Technology

Website: [www.abrasive-tech.com](http://www.abrasive-tech.com)

### Abrasivos Austromex, S.A. DE C.V.

Website: [www.austromex.com.mx](http://www.austromex.com.mx)

### Action Superabrasive Products, Inc.

Website: [www.actionsuper.com](http://www.actionsuper.com)  
VISIT US AT IMTS BOOTH N-7217

### Advanced Abrasives Corporation

Website: [www.advancedabrasives.com](http://www.advancedabrasives.com)

### American Superabrasives Corp.

Website: [www.diamonds-abrasive.com](http://www.diamonds-abrasive.com)

### Anco Industrial Diamond Corp.

Website: [www.ancodiamond.com](http://www.ancodiamond.com)

### Apogee Precision Parts

Website: [www.natchain.com](http://www.natchain.com)

### Asahi Diamond America

Website: [www.asahidiamond.com](http://www.asahidiamond.com)  
VISIT US AT IMTS BOOTH N-7066

### Bogimac NV-SA

Website: [www.bogimac.com](http://www.bogimac.com)

### Bruce Diamond Corp.

Website: [www.brucediamond.com](http://www.brucediamond.com)  
VISIT US AT IMTS BOOTH N-7261

### Cdp Diamond Products Inc.

Website: [www.cdpdiamond.com](http://www.cdpdiamond.com)

### Chardon Tool & Supply Co., Inc.

Website: [www.chardontool.com](http://www.chardontool.com)

### Continental Diamond Tool Corp.

Website: [www.cdtusa.net](http://www.cdtusa.net)

### Crystallume Engineered Diamond Products

Website: [www.crystallume.com](http://www.crystallume.com)  
VISIT US AT IMTS BOOTH W-2206

### Cutting Edge Services Corporation

Website: [www.cuttingedgeservices.com](http://www.cuttingedgeservices.com)

### DCM-TECH, Inc.

Website: [www.dcm-tech.com](http://www.dcm-tech.com)  
VISIT US AT IMTS BOOTH N-7272

### Delaware Diamond Knives Inc.

Website: [www.ddk.com](http://www.ddk.com)

### Desmond-Stephen Mfg Co.

Website: [www.desmond-stephan.com](http://www.desmond-stephan.com)

### Dev Industrial Corp.

Website: [www.dev-group.com](http://www.dev-group.com)

### Diamond Industrial Tools

Website: [www.todit.com](http://www.todit.com)

### Dianamic Abrasive Products Inc.

Website: [www.dianamic.com](http://www.dianamic.com)

### Eastwind Lapidary, Inc.

Website: [www.eastwinddiamondabrasives.com](http://www.eastwinddiamondabrasives.com)

### Element Six

Website: [www.e6.com](http://www.e6.com)

### Eloquence Corporation

Website: [www.corporationwiki.com/New-York/New-York/eloquence-corporation/36629788.aspx](http://www.corporationwiki.com/New-York/New-York/eloquence-corporation/36629788.aspx)

### Engis Corp.

Website: [www.engis.com](http://www.engis.com)  
VISIT US AT IMTS BOOTH N-6751

### FACT USA

Website: [www.wmstrading.com](http://www.wmstrading.com)  
Website: [www.factdiamond.com](http://www.factdiamond.com)

### Fives Landis Corp-Citco/Gardner

Website: [www.fivesgroup.com](http://www.fivesgroup.com)  
VISIT US AT IMTS BOOTH N-7018

### Fort Wayne Wire Die Inc.

Website: [www.fwwd.com](http://www.fwwd.com)

### Greenlee Diamond Tool Co.

Website: [www.greenleediamond.com](http://www.greenleediamond.com)  
VISIT US AT IMTS BOOTH N-7210

### Iljin USA, Inc.

Website: [www.iljindiamond.com](http://www.iljindiamond.com)  
VISIT US AT IMTS BOOTH W-2296

### Industrial Diamond Laboratories Inc.

Website: [www.industrialdiamondlabs.com](http://www.industrialdiamondlabs.com)

### K & Y Diamond Ltd

Website: [www.kydiamond.ca](http://www.kydiamond.ca)

### Lach Diamond, Inc.

Website: [www.lachdiamond.com](http://www.lachdiamond.com)  
VISIT US AT IMTS BOOTH W-2108

### Lieber & Solow Co.

Website: [www.lieberandsolow.com](http://www.lieberandsolow.com)  
Website: [www.landssuperabrasives.com](http://www.landssuperabrasives.com)

### Lunzer Technologies, Inc.

Website: [www.lunzer.com](http://www.lunzer.com)

### Mapal Inc.

Website: [www.us.mapal.com](http://www.us.mapal.com)  
VISIT US AT IMTS BOOTH W-1410

### Megadiamond Inc.

Website: [www.megadiamond.com](http://www.megadiamond.com)

### Morgan Advanced Materials and Technology

Website: [www.morganplc.com](http://www.morganplc.com)

### NanoMech

Website: [www.nanomech.biz](http://www.nanomech.biz)

### National Research Co.

Website: [www.nationalresearchcompany.com](http://www.nationalresearchcompany.com)

### Niabrazo Corp.

Website: [www.niabrazo.com](http://www.niabrazo.com)

### Noritake Co Inc.

Website: [www.noritake.com](http://www.noritake.com)  
VISIT US AT IMTS BOOTH N-7422

### Pinnacle Abrasives

Website: [www.pinnaclesf.com](http://www.pinnaclesf.com)

### Precision Forming

Website: [www.precisionforming.com](http://www.precisionforming.com)

### Protech Diamond Tool Inc.

Website: [www.protechdiamondtoolsinc.com](http://www.protechdiamondtoolsinc.com)

### Radiac Abrasives Inc.,

A Tyrolit Company  
Website: [www.radiac.com](http://www.radiac.com)  
VISIT US AT IMTS BOOTH N-7440

### Sandvik Hyperion

Website: [www.hyperion-sandvik.com](http://www.hyperion-sandvik.com)

### Saint-Gobain Surface Conditioning Group (Saint-Gobain Ceramic Materials)

[www.innovativeorganics.com](http://www.innovativeorganics.com)  
VISIT US AT IMTS BOOTH N-7148

### Scio Diamond Technology

Website: [www.sciodiamond.com](http://www.sciodiamond.com)

### sp3 Cutting Tools Inc.

Website: [www.sp3cuttingtools.com](http://www.sp3cuttingtools.com)

### sp3 Diamond Technologies

Website: [www.sp3diamondtech.com](http://www.sp3diamondtech.com)

### Spec Tool

Website: [www.spec-tool.com](http://www.spec-tool.com)

### Standard Die & Fabricating Inc.

Website: [www.standarddie.com](http://www.standarddie.com)

### H.C. Starck, Inc.

Website: [www.hcstarck.com](http://www.hcstarck.com)

### Sumitomo Electric Carbide Inc. Materials Group

Website: [www.sumicarbide.com/diamondgroup](http://www.sumicarbide.com/diamondgroup)  
VISIT US AT IMTS BOOTH W-2422

### Superabrasives Inc.

Website: [www.superabrasives.com](http://www.superabrasives.com)  
VISIT US AT IMTS BOOTH N-7324

### Syntech Abrasives Inc.

Website: [www.syntechabrasives.com](http://www.syntechabrasives.com)

### Tomei Corp. of America

Website: [www.tomeidiamond.com](http://www.tomeidiamond.com)

### US Synthetic Corporation

Website: [www.ussynthetic.com](http://www.ussynthetic.com)

### Ulbrich Stainless Steels & Special Metals, Inc.

Website: [www.ulbrich.com](http://www.ulbrich.com)

### Vollmer of America Corporation

Website: [www.vollmer-us.com](http://www.vollmer-us.com)  
VISIT US AT IMTS BOOTH N-6875

### Wemex Superabrasivos, S. DE R.L. DE C.V.

Website: [www.wemex.com.mx](http://www.wemex.com.mx)

### Worldwide Superabrasives, LLC

Website: [www.worldwidesa.com](http://www.worldwidesa.com)

### YG-1 USA

Website: [www.yg1usa.com](http://www.yg1usa.com)  
VISIT US AT IMTS BOOTH W-2436

### Zhongnan Diamond Co., Ltd

Website: [www.diamond-zn.com](http://www.diamond-zn.com)

# ILJIN Diamond

## IBN

- Cubic Boron Nitride products suitable for grinding automotive and aerospace components



- ✓ Low power consumption
- ✓ Sharp cutting-edge
- ✓ Fast regeneration of sharp cutting edge
- ✓ Longer tool life



Excellent for  
Cam · Crankshaft Grinding

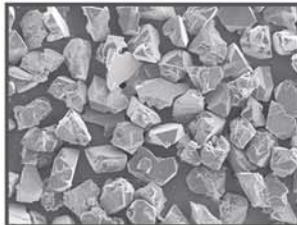

- ✓ Friable & Irregular shape
- ✓ Low power consumption
- ✓ High efficiency production
- ✓ Sharp cutting-edge



Excellent for  
Bearing Grinding

## IBON

- PCBN (Polycrystalline Cubic Boron Nitride) composites available from low CBN content to high CBN content



for

- ✓ Cast Irons - Roughing: SB100(Solid), Finishing: SB95N, SB95S2
- ✓ Hardened Steels Continuous - SB500, SB600
- ✓ Hardened Steels Interrupted - SB650, SB600, SB630, SB700
- ✓ Powdered Metals - SB700, SB95S2, SB95N
- ✓ Solid Form Available - SB100, SB500, SB600, SB630, SB650, SB700
- ✓ RTG(Ready To Grind) Available: Brazed Semi-Finished



## Tungsten Carbide products

- Available in various specifications



for

- ✓ PCB Micro Drill - N810X, M710
- ✓ PCB Router and End Mill - HF6
- ✓ End Mill, Drill, Reamer
  - EF8: Hardened steel, Cast iron, Al alloy
  - EF10, HF10, TH1008: General steel, Stainless steel, Ti alloy
  - EF12, HF12: Soft steel, Stainless steel, Cast iron
  - TH608: CFRP, Graphite (for CVD Diamond Coating)



**The Industrial Diamond Association of America Announces INTERTECH 2015**  
**May 19 & 20**



# INTERTECH 2015

**An International Technical Conference on Diamond, Cubic Boron Nitride and their applications.**

**[www.intertechconference.com](http://www.intertechconference.com)**

**Indianapolis Downtown Marriott**  
**INDIANAPOLIS, INDIANA USA**  
**May 19 & 20, 2015**

## **INTERTECH 2015 WILL BE THE FEATURED CONFERENCE FOR NEW TECHNOLOGY AND APPLICATION DEVELOPMENT OF SUPERABRASIVES AND SUPER-HARD MATERIALS**

**INTERTECH 2015** is the leading International Technical Conference on industrial diamond, cubic boron nitride, polycrystallines, CVD diamond, CVD Cubic Boron Nitride, Nanodiamond and other materials classified as superabrasives and ultra-hard materials.

**INTERTECH 2015** will serve as a forum for leading experts representing international suppliers, manufacturers, research facilities, academia, end-users, machine tool builders and the scientific community. They will be presenting papers on subjects that will introduce new and thought-provoking technology on industrial and commercial levels. This will be an international "meeting of the minds" for every aspect of ultra-hard material science.

## **AUTOMOTIVE FEATURED INDUSTRY**

With **INTERTECH 2015** being held in Indianapolis during May it follows that the automotive industry will be a featured industry. The automotive industry is a major user of superabrasives and implements new applications and innovations throughout their manufacturing operations using diamond and cubic boron nitride materials. The parts manufactured for automotive (including racing) are made from materials such as Metal Matrix Composites, High Silicon Aluminum, Ceramics, Bi-Metals, Glass and other difficult to machine and grind raw materials. These materials require the high productivity, close tolerances and superior performance attainable only by diamond and cBN tooling for machining, grinding and other material removal and finishing operations.

## **INDIANAPOLIS IS A MAJOR ATTRACTION ...**

Over 20 million people will arrive in Indianapolis next year. A few of these will attend **INTERTECH 2015**. In May, Indianapolis hosts the INDIANAPOLIS 500, heralded as The Greatest Spectacle in Racing. It is only appropriate that **INTERTECH**, the greatest spectacle in superabrasives, be held in the same month. **INTERTECH** has been held in many locations over the last 14 years and in 2015 this sensational event will be held in Indianapolis, Indiana USA. **INTERTECH** is known for excellent locations and exceptional service and **INTERTECH 2015** will carry on that tradition at the Indianapolis Marriott Downtown. We are anticipating the usual excellent attention and personal service that has become the standard of **INTERTECH** conferences. The Marriott boasts beautiful accommodations, revamped meeting rooms and luxurious amenities. The Marriott is conveniently located in the center of downtown Indianapolis surrounded by excellent restaurants, attractions and shops. **INTERTECH 2015** will be a rewarding technical experience complimented by this excellent venue.

Internationally famous, the Indianapolis Motor Speedway is home to the world's largest single-day sporting event, the Indianapolis 500. The track opened in 1909 and is the world's largest spectator facility. It is so large that you could fit the Roman Coliseum, Vatican City, Wimbledon Campus, Rose Bowl, Yankee Stadium and Churchill Downs inside the 2.5-mile oval. The Downtown Marriott is conveniently linked to Circle Centre, a four-level urban mall anchored by Carson Pirie Scott a downtown landmark. On the city's north side, The Fashion Mall at Keystone presents such options as Saks Fifth Avenue and Crate & Barrel. Smaller, uniquely local shops are found within the city's various Cultural Districts. Downtown has great restaurants, ranging from Shapiro's (one of America's greatest delis), to Goose The Market, one of the Top 10 U.S. sandwich shops, to St. Elmo Steak House, home of the hottest meal in the world. Other attractions include The Indianapolis Zoo (located in the nation's only urban cultural state park) is ranked among the nation's top 10 zoos and the Indianapolis Museum of Art – one of the country's 10 largest and oldest general art museums. All of this complements **INTERTECH 2015** to make it a "have to attend" conference!

## **YOU CAN BE A PART OF THIS EXCITING EVENT!**

We are now soliciting commercial and technical papers of approximately 30-45 minutes in length that address the research of these super-hard materials as well as the dynamics and application of superabrasive systems in automotive and other industries as well (see: Areas of Consideration) with a focus on new technology, tooling, workpiece materials, machines and applications related to increased **PRODUCTIVITY** and **PERFORMANCE**. Consideration for papers is being made at this time and abstracts are now being accepted; contact us today to be considered. This will be the most comprehensive event ever held on super-hard materials for automotive and similar industries!

Photos of Indianapolis for INTERTECH 2015 courtesy of Indianapolis Convention & Tourism Bureau.

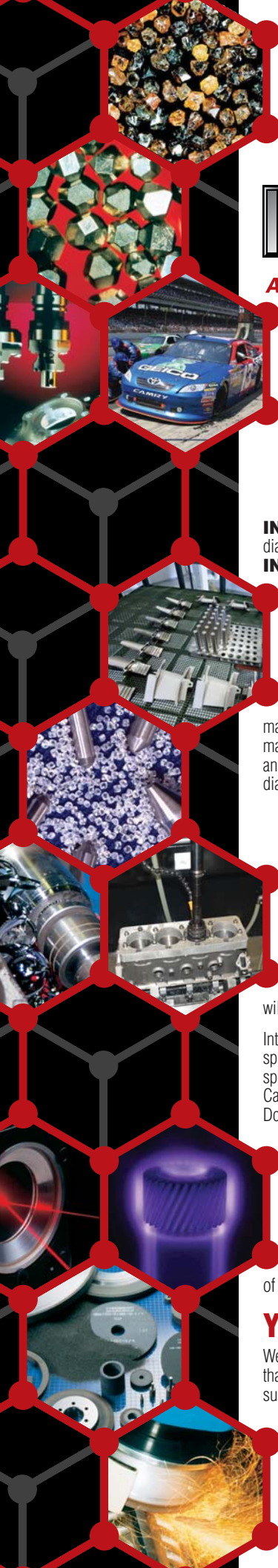

# AREAS OF CONSIDERATION FOR PAPERS FEATURING PAPERS ON SUPERABRASIVES FOR AUTOMOTIVE

## AUTOMOTIVE

- Parts Manufacturing
- Gears
- Wheels
- Transmissions
- Engines

## MACHINE TOOLS

- Development
- Innovations
- Advancements
- Superabrasive

## RESEARCH & DEVELOPMENT

- New Crystals & Abrasives

- New Coatings
- Bond Development
- Testing/Gauging
- Tool Fabrication
- Materials
- Tooling
- Application Development
- HPHT Technology
- Film (CVD & PVD)
- Magnetorheological Finishing
- Electrolytic In-process Dressing (ELID)

- Mirror-Surface Grinding
- Nanotechnology

## TOOLING

- Grinding Wheels
- Cutting Tools
- Drill Bits

## WEAR PARTS

- Rests
- Anvils
- Nozzles

## WORKPIECE MATERIALS

- Metal Matrix Composites
- Bi-Metals

- High Tech Ceramics
- High Silica Aluminum
- Glass
- New Materials & Alloys
- Thermal Sprays
- Superalloys
- Nano-Structured Materials

## OTHER NEW TECHNOLOGY & APPLICATION DEVELOPMENT

# OTHER INDUSTRIES AND TOPICS FOR CONSIDERATION

## AEROSPACE

- Manufacturing
- Rebuilding

## CONSTRUCTION/HIGHWAY

- Concrete Aggregates & Variables
- Highway/Runway
- Grinding & Grooving
- Bridge Repair
- Renovation
- Block Grinding
- Polishing

## ELECTRONICS

- Disc Texturing
- Wafer Mfg.
- Polishing
- Optic Windows
- Semiconductors
- Heat Sinks

## EMERGING TECHNOLOGY

- CVD Diamond
- Nanodiamond
- New Crystals
- Coatings

## GLASS

- Lens Generation
- Polishing
- Pencil Edging

## MACHINE TOOLS

- Development
- Innovations
- Advancements
- Superabrasive Adaptation

## MEDICAL

- Surgical Knives
- Prosthesis Fabrication

## MINING/DRILLING/NATURAL RESOURCE EXPLORATION

- Drills & Bits
- Application

## NANOTECHNOLOGY

- Medical Developments
- Industrial Applications
- Electronics
- Other Research & Developments

## OTHER MANUFACTURING

- Pumps
- Motors
- Heavy Equipment

## OPTICS

- Polishing
- Lens Generation
- Diamond Coating

## RESEARCH & DEVELOPMENT

- New Crystals & Abrasives
- New Coatings
- Bond Development
- Testing/Gauging

- Tool Fabrication
- Materials
- Tooling
- Application Development
- HPHT Technology
- Film (CVD & PVD)
- Magnetorheological Finishing
- Electrolytic In-Process Dressing (ELID) Mirror-Surface Grinding
- Nanotechnology

## STONE PROCESSING

- Quarrying
- Sawing
- Polishing

## SUPPLIERS TO SUPERABRASIVE INDUSTRY

- Metals
- Coolants
- Measuring & Gauging
- Safety
- Pressing Equipment

## TOOLING

- Grinding Wheels
- Cutting Tools
- Sawblades
- Drill Bits

## WEAR PARTS

- Rests
- Anvils

## NOZZLES

## WIRE DRAWING

- New Technology
- Applications
- Application
- Single Crystal
- PC

## MANUFACTURING WOODWORKING

- Hard Woods
- Fiberboard
- Laminates
- Composites

## WORKPIECE MATERIALS

- Metal Matrix Composites
- Bi-Metals
- High Tech Ceramics
- High Silica Aluminum
- Wood & Wood Composites
- Glass
- Stone
- Concrete
- New Materials & Alloys
- Thermal Sprays
- Superalloys
- Nano-Structured Materials

## OTHER NEW TECHNOLOGY & APPLICATION DEVELOPMENT

## WATCH FOR INTERTECH 2015 ON-LINE

As you can see by the areas for paper consideration, diamond and cubic boron nitride are not just being used as abrasives in traditional applications. Today, superabrasives and ultra-hard materials are making inroads in electronics, medical, cosmetics and literally every other industry where the characteristics of diamond and cubic boron nitride can affect performance or provide higher strength or new capabilities. As an **INTERTECH** attendee you will learn how these new products and applications are being developed, where super-hard materials are being used and how you can apply these systems in new and innovative ways. Visit the **INTERTECH 2015** website: [www.intertechconference.com](http://www.intertechconference.com) for additional information on:

- CONFERENCE REGISTRATION
- ABSTRACT SUBMISSION
- LOCATION & TRAVEL
- SESSIONS & SCHEDULES
- PAPER GUIDELINES
- VISAS & INVITATION LETTERS
- SPEAKERS & TOPICS
- TABLETOP DISPLAYS
- KEYNOTE ADDRESSES
- ORGANIZING COMMITTEE CONTACTS

On-Line submission of abstracts is now available at [www.intertechconference.com](http://www.intertechconference.com). If you wish to present a paper, you can also send a one or two paragraph abstract of your paper topic via email, fax or regular post to: Terry M. Kane, Chairman • **INTERTECH 2015** • P.O. Box 29460 • Columbus, Ohio 43229 • Telephone: 614-797-2265 • Fax: 614-797-2264 • e-mail: [tkane-ida@insight.rr.com](mailto:tkane-ida@insight.rr.com)

## ABSTRACTS WILL BE ACCEPTED FROM JULY 1, 2014 THROUGH JANUARY 1, 2015

We will reply to all submissions. Come join us! **INTERTECH** has the tradition of being the most comprehensive event held on superabrasives and ultra-hard materials.

(PLEASE PRINT CLEARLY AND FILL OUT COMPLETELY. **INCLUDE ABSTRACT**)

Honorable (Mr, Mrs, Miss, Ms.): \_\_\_\_\_

Last Name: \_\_\_\_\_ First Name: \_\_\_\_\_

Title (PhD, Dr., Other): \_\_\_\_\_ Business Title (CEO, Mgr., Eng., etc.): \_\_\_\_\_

Company: \_\_\_\_\_

Date: \_\_\_\_\_

Street Address: \_\_\_\_\_

City: \_\_\_\_\_ State/Province: \_\_\_\_\_ Zip/Postal Code: \_\_\_\_\_

Country: \_\_\_\_\_

Phone: \_\_\_\_\_ Fax: \_\_\_\_\_

Cell/MobilePhone: \_\_\_\_\_ Email: \_\_\_\_\_

Website: \_\_\_\_\_

Paper Title: \_\_\_\_\_

# Calendar of EVENTS

To have your event or conference listed, please send information to: *Finer Points Event Calendar* • P.O. Box 29460, Columbus OH 43229 • Fax 614-797-2264 or email: tkane-ida@insight.rr.com



**August 21, 2014**  
**ATI Industrial Automation's 8th Annual Technology Fair**  
 8:00am until 3:00pm  
 ATI Michigan Sales Office  
 4577 South Lapeer Rd, Suite 1  
 Orion Township, MI 48356 USA  
[www.atia.com/Company/EventRegistration.aspx](http://www.atia.com/Company/EventRegistration.aspx)



**September 8-13, 2014**  
**International Manufacturing Technology Show**  
 McCormick Place • Chicago, IL USA  
[www.imts.com](http://www.imts.com)



**September 17-19, 2014**  
**SAE 2014 North American International Powertrain Conference**  
 Chicago, IL USA



**October 14-16, 2014**  
**Global Forecasting & Marketing Conference**  
 MGM Grand Detroit  
[www.amtonline.org/moreinfo/gfmc-2014](http://www.amtonline.org/moreinfo/gfmc-2014)

## JIMTOF 2014

Oct 30 (Thu) - Nov 4 (Tue)  
 Venue: Tokyo Big Sight (Tokyo International Exhibition Center)  
 Organizers: Japan Machine Tool Builders' Association / Tokyo Big Sight Inc.

**October 30 - November 4, 2014**  
**Japan Machine Tool Fair**  
 Tokyo Big Sight (Tokyo International Exhibition Center) Japan  
[www.jimtof.org](http://www.jimtof.org)



**November 10-11, 2014**  
**Concrete Sawing & Drilling Association Slab Sawing & Drilling 201**  
 St. Petersburg College  
 Clearwater, Florida USA  
[www.csda.org](http://www.csda.org)



**November 12-13, 2014**  
**Concrete Sawing & Drilling Association Wall & Hand Sawing 201**  
 St. Petersburg College  
 Clearwater, Florida USA  
[www.csda.org](http://www.csda.org)



**November 11-13, 2014**  
**FABTECH®**  
 Georgia World Congress Center  
 Atlanta, Georgia USA  
[www.fabtechexpo.com](http://www.fabtechexpo.com)



**November 13, 2015**  
**Industrial Diamond Association of America Superabrasive Materials, Principles & Applications**

**Education Course**  
 Huntsville, Alabama USA  
[www.superabrasives.org](http://www.superabrasives.org)



**COMPOSITESWORLD**  
**CARBON FIBER**

**December 9-11, 2014**  
 Hilton La Jolla  
 Torrey Pines - La Jolla, CA, USA  
[www.compositesworld.com/conferences/compositesworld-2014-carbon-fiber-conference](http://www.compositesworld.com/conferences/compositesworld-2014-carbon-fiber-conference)

## Calendar Dates for 2015



**May 18, 2015**  
**Industrial Diamond Association of America Annual Meeting**  
 Marriott Indianapolis Downtown  
 Indianapolis, Indiana USA  
[www.superabrasives.org](http://www.superabrasives.org)

**May 19-20, 2015**  
**Indianapolis Marriott Downtown**



An International Technical Conference on Diamond, Cubic Boron Nitride and their applications.  
[www.intertechconference.com](http://www.intertechconference.com)  
 Indianapolis Downtown Marriott  
 INDIANAPOLIS, INDIANA USA  
 May 19 & 20, 2015

350 West Maryland Street  
 Indianapolis, Indiana USA  
[www.intertechconference.com](http://www.intertechconference.com)

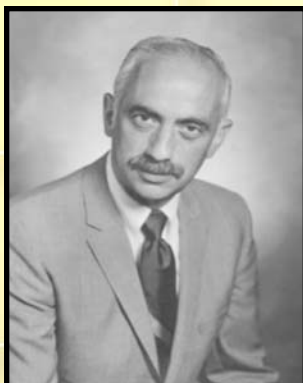

## In Memoriam

**E. Louis "Lou" Kapernaros, 90**  
**January 10, 1924 to**  
**June 16, 2014**

*Lou Kapernaros, the retired General Manager of GE Specialty Materials Department (SMD), was one of the diamond industry's greatest leaders.*

Lou was a PFC in the US Army during WWII and served as a medic in the European theatre. Upon discharge, he attended the Missouri School of Mines, receiving a BS in metallurgical engineering. Prior to GE Lou worked at several companies involved in metalworking and manufacturing and then took an engineering job with General Electric's Metallurgical Products Division. GE was the recognized inventor for the first reproducible manufacturing process for industrial diamond and Lou joined the effort at GE to commercialize industrial diamonds. Lou started in Detroit on the Diamond Project and became Manager of the newly established Application Development Laboratory. The "Diamond Business" moved to Worthington Ohio in 1968 and Lou was General Manager from 1971 through 1987. Lou was a visionary leader who took pride in his global sales and application

engineering network that was complimented by an R&D department producing new products at breakneck speed. During Lou's tenure, the diamond business and the entire industry expanded with new applications and products. Under Lou's direction GE was the first to introduce cubic boron nitride (cBN), high grade saw diamond, polycrystalline diamond, polycrystalline cBN, drill diamond, polycrystalline wire dies, crystal coatings and myriad other products and variations that revolutionized material removal in all industries. These new products became known as "superabrasives" a term introduced to the marketplace by Lou's team. Lou's peers have stated, Lou had the "gut feel" for the industrial diamond industry that enabled him to make the right investments at the right time, and the unique ability to attract clever and talented professionals to develop, make, and market superabrasive products. Lou's insight led to the construction of a second diamond plant in Ireland and the establishment of Application Laboratories in Japan and Germany. Lou was known for his strong customer relationships and GE grew to become the worldwide leader in industrial superabrasives. After his retirement, Lou continued to be active in the industry and was widely sought after as a consultant or partner for his knowledge and insight about the diamond industry. In 2008, the Industrial Diamond Association of America recognized Lou's contributions to the industry with an Honorary Lifetime Membership Award. The plaque he received closed with these words: "Your leadership was an inspiration to everyone who was fortunate enough to meet you, not just in your own company, but also with other business leaders throughout the entire industry. You were pivotal in bringing about many positive changes in the diamond industry and you were a catalyst for growth in those early and very exciting years."



# AD INSERTION ORDER

ADVERTISING IN FINER POINTS IS THE BEST WAY TO GET YOUR PRODUCTS SEEN

# Finer Points

## SUPERABRASIVE INDUSTRY REVIEW

P.O. Box 29460 • Columbus, Ohio 43229 • USA • Phone: (614) 797-2265 • Fax: (614) 797-2264 • E-Mail: TKane-IDA@insight.rr.com

The undersigned is purchasing a \_\_\_\_\_ page ad for his/her firm at \$ \_\_\_\_\_ per issue  
for \_\_\_\_\_ times beginning with the \_\_\_\_\_, 20 \_\_\_\_\_ issue.

Commissionable at 15% for recognized Ad Agencies, if invoice paid within 30 days.

Date \_\_\_\_\_ Signed by \_\_\_\_\_

### ADVERTISER:

Company \_\_\_\_\_ Contact \_\_\_\_\_

Address \_\_\_\_\_

City \_\_\_\_\_ State/Province \_\_\_\_\_ Country \_\_\_\_\_

Zip/Postal \_\_\_\_\_ Telephone \_\_\_\_\_ FAX \_\_\_\_\_

Email \_\_\_\_\_

**AGENCY:** \_\_\_\_\_ Contact \_\_\_\_\_

Address \_\_\_\_\_

City \_\_\_\_\_ State/Province \_\_\_\_\_ Country \_\_\_\_\_

Zip/Postal \_\_\_\_\_ Telephone \_\_\_\_\_ FAX \_\_\_\_\_

Email \_\_\_\_\_

### 2014 ADVERTISING RATES

#### IDA MEMBERS RECEIVE 50% AD DISCOUNT

Please check size of advertisement desired. You will be invoiced

	Frequency	1X	4X
Full-page, 7-1/2"W x 10"H, 4 Color		\$3800	\$3270
Full-page, 7-1/2"W x 10"H, Black/2nd Color		\$3270	\$2750
Full-page, 7-1/2"W x 10"H, B & W		\$2820	\$2560
Half-page, 5"W x 7-1/2"H, Four Color		\$2230	\$1960
Half-page, 7-1/2"W x 5"H, Four Color		\$2230	\$1960
Half-page, Either Size, Black/2nd Color		\$1960	\$1710
Half-page, Black & White		\$1710	\$1580
1/3 page, 2-3/8"W x 10"H, 4 Color		\$1840	\$1710
1/3 page, 2-3/8"W x 10"H, B & W		\$1710	\$1580
1/4 page, 4-3/4"W x 4-3/4"H, Color		\$1580	\$1440
1/4 page, 4-3/4"W x 4-3/4"H, B & W		\$1440	\$1360
Back Cover, Full-page, 4 Color Only	4X Only	\$5380	
Inside Front Cover, Full-page, 4 Color Only	4X Only	\$5100	
Inside Back Cover, Full-page, 4 Color Only	4X Only	\$4980	

#### Additional Charges (non-commissionable):

BLEED (full page - 8-3/4" x 11-1/4") \$125 additional charge \_\_\_\_\_

PAGE SELECTION \$175 additional charge \_\_\_\_\_

Classified ad rates are Non-commissionable \$85 IDA members

\$170 - non-members \_\_\_\_\_ All 2-1/4"W x 2-1/4"H

### 2014 EDITORIAL CALENDAR

Planned issues, topics and closing dates\*:

Issue:	Editorial Feature*:	Closing
Winter 2013/2014	Materials and Processing	Dec. 1, 2013
Spring 2014	Testing Facilities & Equipment	March 1, 2014
Summer 2014	IMTS Preview, Education Program and INTERTECH 2015 Call for Papers	July 1, 2014
Fall 2014	Diamond, cBN and Polycrystalline Materials - INTERTECH 2015	Sept. 1, 2014
Winter 2014/2015	Superabrasive Industry Review INTERTECH 2015	Dec. 1, 2014

\*Editorial topics & closings subject to change

### SHIPPING INSTRUCTIONS

Fax, mail or email all printing materials to:

Production Manager

#### FINER POINTS MAGAZINE

P.O. Box 29460 • Columbus, Ohio 43229 USA

Phone: 614-797-2265 • Fax: 614-797-2264

E-Mail: tkane-ida@insight.rr.com



**APOGEE** PRECISION  
PARTS

ISO 9001:2008 CERTIFIED



# QUALITY SERVICE DESIGN

The Apogee design team is focused on your individual needs and requirements to insure that every aspect of your custom project will be handled with the highest degree of professionalism.

We offer a unique process that insures the highest quality product at the most competitive price and our staff understands the importance of a working relationship with our customers to guarantee their complete satisfaction.

You will be extremely pleased with our knowledge and unmatched quality due to decades of experience in drawing refractory metals including Tantalum, Niobium, Zirconium and Titanium cans and cups.

Call or email us today to discuss your individual requirements and allow us to provide you with a custom competitive quote.

55 Access Road • Suite 600 • Warwick, Rhode Island 02886 U.S.A.  
(401) 732.3634 • Fax (401) 732.5237 • E-mail: [info@apogeeparts.com](mailto:info@apogeeparts.com) • [www.apogeeparts.com](http://www.apogeeparts.com)



INDUSTRIAL DIAMOND ASSOCIATION OF AMERICA (IDA) INTRODUCES

## ***“BEST IN CLASS”***

### ***Education Course for Superabrasive Materials, Principles & Applications***

The Industrial Diamond Association of America announces the Superabrasive Materials, Principles & Applications education course being held November 13th 2014 in Huntsville Alabama.

This course is unique from the standpoint it will be taught by IDA Members who are the industry experts from the leading superabrasive suppliers, tool manufacturers and machine tool builders. These are the top experts in the industry with “real world” knowledge of superabrasives, applications and parameters. These instructors have already established manufacturing operations in aerospace, automotive and literally every other production operation around the world. Now, you can learn what superabrasives are, where they are used and the characteristics and properties that affect their performance in manufacturing operations. Do you want to understand wear mechanisms in machining and grinding? What is a rake angle? What effects chip formation? How does burn and thermal damage effect structural integrity of a part? What is residual stress in metal components such as turbine engine fan blades? What is the Modulus of Resistance and what abrasive performs best on a particular workpiece material and why? All these questions will be answered and explained in great detail!

The IDA wants to spread the word about the productivity and performance of superabrasives and this “low cost” session will be a first in this industry! Education is the key to manufacturing success. Every news report highlights the fact that education is critical in today’s workplace. Manufacturing operations use sophisticated machines to machine and grind components for literally every industry. Our industry leaders have stated that we have a shortage of qualified operators. In addition, supervisors, operations managers and engineers at manufacturing sites are demanding education on the new materials being used and the new superabrasives being applied. Experts agree that there is a clear conceptual difference between education and training. Training is the passing of information on to a trainee so that individual can do a particular job or operation whether they understand all the nuances of what they are doing or not. Education on the other hand is imparting information to an individual so they can take that knowledge and apply it to any number of different applications or operations and know what they are doing and why!

Superabrasives are unique and the way they are applied is critical to their success in any application. With all the exotic and difficult to machine and grind materials (metal matrix composites, high silicon aluminum, superalloys, hardened steel, bi-metals, cermets, composites, etc.) it is paramount that everyone involved in any portion of the manufacturing or engineering process be well-educated on the application and use of superabrasives. This course developed by member companies of the Industrial Diamond Association of America is the most comprehensive course ever established to educate all levels of personnel.

The IDA has always been a driving force in research and the development of education and training for this industry. Member companies created the first known literature and application guidelines back in the early 20th century when diamond was being applied in carbide grinding. In the 21st century the IDA is reinventing those guidelines to meet today’s applications of superabrasives on the wide range of materials being used in all industries.

The IDA is made up of the true experts in every aspect of grinding and machining. It only makes sense industry should look to us once again to lead the way in educating operators, engineers, supervisors and everyone else involved with grinding or machining operations in the industrial world. Let’s make sure the new breed involved in manufacturing operations is not just trained but educated to a new level of expertise! Learn from the experts who have researched and invented industrial diamond, CVD diamond, nanodiamond, cubic boron nitride (cBN) and polycrystalline materials.

**Make plans to attend the Superabrasive Materials, Principles & Applications education course coming in November! Get a true education on superabrasives and not just another training session. Space is limited, so register today! Watch for additional details and REGISTER ON-LINE AT [WWW.SUPERABRASIVES.ORG](http://WWW.SUPERABRASIVES.ORG)**



# Gehring Technologies GmbH Honing of Gears

**By: Dipl.-Ing. (FH) Gerhard Flores, Manager of Process Development – Gehring Technologies GmbH**

**Dr.-Ing. Andreas Wiens, Team Leader of Process – Gehring Technologies GmbH**

**Dipl.-Ing. Oliver Stammen, Sales Manager – Thielenhaus Technologies GmbH**

## Summary

The possibility of position correction with high precision and material removal of up to 0.350 mm in 18 s puts the single-machine honing of transmission gears and other components firmly in the forefront of current automotive manufacturing technology. Despite very high cutting performance, the low machining forces and temperatures enable the lowest marginal zone variances and high residual compressive strength. The surface roughness with a high material content in low cutting depth and the hone angle structure have a positive tribological effect on the sliding function of the gear. An additional innovative manufacturing strategy is the use of machines for combination machining. This fact is especially advantageous in the machining of planetary gears. Here, the process of flat finishing, ID grinding and honing are systematically combined in a single machine, as detailed in this article.

## Introduction

The honing of gears, by definition, facilitates ease of operation, low noise and smoother performance in a transmission. Honing also contributes to reduced friction in the powertrain. Both the intense cutting (roughing process) as well as the functionally fine finishing of transmission gears can be performed in one setup, on one machine. Honing in mass production is a well-established process, owing to the intelligent machine layout and other combinations with defined cutting geometries. It should be technologically and economically considered as a serious production method. Furthermore, the combined process of flat surfacing and honing on one machine is a further recent innovation for the finish machining of planetary gears in mass production.

The design of components for modern vehicle transmissions such as manual, automatic or dual clutch styles seeks to reduce friction, thereby increasing gear efficiency in addition to function. Therefore, for the gear bores of various active transmission components and planetary gears, there is the requirement for low-friction and wearresistant contact topographies. Also, there is the desire for economical finish machining of the bore in one process, whenever possible.

The finish machining of transmission components in mass production is currently being done using rough honing and finish honing. In one process, consisting of two steps on one machine, the functionally accurate shape and position tolerances, as well as the desired surface structure, can be achieved. Therefore, secondary hard turning and grinding processes are seldom required as finish processes in mass production, neither individually nor as combined processes in a work cell.

The diverse quality characteristics require an adjustment to individual process components of honing. The manufacturing quality of the conventional hone process is defined by the terms "dimensional tolerance" and "surface finish." Furthermore, for the function of gear wheels, the quality terms "axial run-out" and respectively, "perpendicularity" and "radial run-out" (out of round) are relevant. If one also wants to use honing for the finishing of gear wheels, the process of these broadened quality terms is modified accordingly.

## Function and Quality

The bore in a transmission component functions as a rotary and translational slideway. The tolerances are selected accordingly. The honed topography with high material mass benefits the frictional behavior and homogenizes the application of force. The honed surface profile with a large topographical contact surface enables a stabilization of the lubricating film, when mixed friction occurs. The loaded contact surfaces have a high adhesion for the gear oil, which prevents a breakdown of the lubricating film on the contact surfaces. This acts to reduce friction and minimize wear in the switched condition with high system pressure on the contact surfaces as well as the unloaded rotating idler. Also, the hone angles contribute to the even distribution of the lubricating oil in the lengthwise and circumferential direction of the bore.

In order to avoid local high surface pressures, there are also tight shape and position tolerances of the required macro-geometrical conditions for equal lubrication gap widths. The tight geometrical tolerances (axial runout) and radial run-out have a positive effect on the smooth operation of the gear wheel sets. This is the purpose of the statistical tolerance limits. At a machine capacity of cmk 3 1.33, for example, the straightness is reduced from 3  $\mu\text{m}$  to about 2.1  $\mu\text{m}$ , despite very different wall thicknesses. Honing involves the boring of gear wheels (such as planetary gears, transmission gears, switching sleeves, layshaft gears, bevel gears) of various shape, dimension, material and hardness. Honing of transmission gears goes beyond the previous quality terms. The following tolerances can be defined (Tab. 1):

In addition to the geometric tolerances, highly stressed components

are increasingly evaluated according to the marginal zone of the functional surface. The mechanical and thermal stress of the material due to the machining forces during the final machining steps contributes to the microstructure in the area near the surface. Here, there are significant differences between the process used and the finishing operation. The honing process is one operation with comparatively low machining forces and temperatures. The conditions for developing a lasting, highly durable marginal zone are therefore especially advantageous with honing. Therefore, hardened parts are also the subject of material testing in terms of compressive stresses that positively influence the fatigue strength of highly stressed bore surfaces.

### Honing Control Wheels Machining Principle

An important feature of honing is the alignment of the tool axis and bore axis. In the conventional layout of tool and part, the expansion of the tool results in an equiaxial alignment. The tool-part system has designated degrees of motion freedom which enables the centering and tipping up to identical axis position. An improvement in dimension, shape and surface quality is achievable with this mechanical system.

If the position of the bore needs to be corrected, that is, the perpendicularity of the bore axis to the front face or the axial runout of the front face to the bore axis, the angular degree of freedom (tilting) must be replaced by a rigid perpendicular positioning of the tool axis and clamping surface. The reference surface for honing is the machined front face, which is supported on the clamping level (Dia. 1). Centering on an inaccurate gear tip circle diameter is not necessary. As a result, the center of the gear wheel bore can align itself to the tool via the floating part holder. Due to this condition, the radial run-out (bore to gear teeth) remains unchanged. The deviation of the angle position of the bore axis to the tool axis is corrected in the subsequent material removal. Next, the tool machines the raised areas of the lateral surface. With the additional clamping, the entire bore is machined and a new bore axis is established.

### Honing Transmission Components-Machining Concept

The common principle among the various possibilities for gear wheel machining is the moveable part holder and the rigid tool holder. Also, the











<b>Dimensional tolerance</b>		Diameter	
<b>Shape tolerance</b>	  	Cylindricity Roundness Straightness	
<b>Directional tolerance</b>	 	Parallelism Perpendicularity	
<b>Run out tolerance</b>	 	Axial run-out, Radial run-out	
<b>Surface tolerance</b>		arithm. mean deviation $R_a$ averaged surface roughness $R_z$	

Table 1: Quality Characteristics for Honing Gears

## YOUR SOURCE FOR DRAW QUALITY TITANIUM, NIOBIUM AND ZIRCONIUM

ULBRICH STAINLESS STEELS  
& SPECIAL METALS, INC.  
EMAIL [TiNbZr@ulbrich.com](mailto:TiNbZr@ulbrich.com)  
203 239-4481

[WWW.ULBRICH.COM](http://WWW.ULBRICH.COM)



<b>GLOBAL PARTNER IN THE STAINLESS STEELS AND SPECIAL METALS MARKET SINCE 1924</b>	<b>CUSTOM PRECISION ROLLED STRIP, FOIL AND WIRE</b>	<b>TIGHTER THAN INDUSTRY STANDARD TOLERANCES</b>	<b>13 LOCATIONS WORLDWIDE</b>
--	---	--	-------------------------------

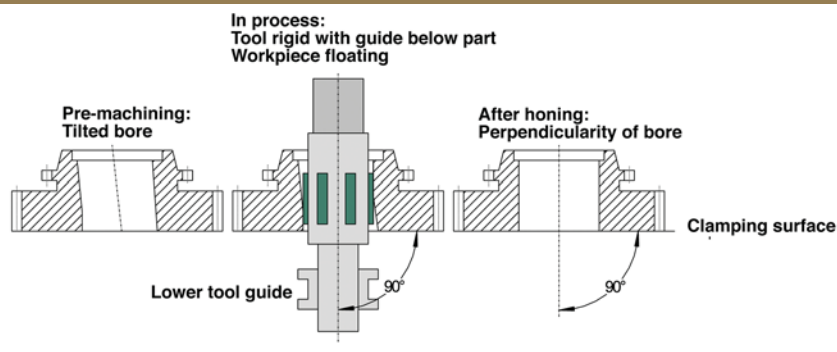

Diagram 1: Machining Principle for Position Correction of Gear Wheel Bores in Gear Wheels

conventional honing process with adjustable honing stones has been carried through. For honing such components, vertical rotary indexing machines with the single part holder in floating fixtures are used (Tab. 2). The preparation consists, as a rule, of boring and hardening, so that they must be machined in two honing operations. The tools are exclusively loaded with CBN-abrasives. Furthermore, fully automated production honing machines are equipped with various standard components such as gage stations, handling systems, forcecontrolled electromechanical feed devices (EMZ-F) and electromechanical ballscrew stroke drives.

## Honing Transmission Components-Requirements and Process Considerations

Because honing of hardened gear wheels has undergone major development in the past few years, this illustration is presented simply as an example. The hardened gear wheels are mainly machined on fully automatic, multiple spindle, rotary indexing honing machines. The machining concept for individual machining consists of conventional multiple stone tools. The attachments are designed to be interchangeable for various gear wheels. Honing a gear wheel bore is defined by the following quality terms and tolerances (Tab. 3):

The high stock removal during rough honing with a honing allowance of up to 0.350 mm is the prerequisite for the successful implementation of the honing process in the mass production of gear wheels. This is how honing maintains its competitiveness compared to hard turning. The smoothing of the surface end quality takes place in the 2nd machining station only by changing the cutting material and adjusting the process parameter. The radial runout achieved in pre-machining should remain unchanged. The layout of a machine for machining gear wheels shows the stations named in Table 2. After the load and unload station, the mechanical pre-gaging is performed. Here, the minimum dimension of the bore is checked, in order to prevent a collision with the tool. Rough honing works with robust parameters, especially with high cutting speed of about 150 m/min and large removal rates of about 20-30  $\mu\text{m/s}$  in diameter. The subsequent finish honing operation completely removes the rough profile of the rough honing operation and leaves behind the functional component quality (Dia. 2). Pneumatic post-gaging is the final quality assurance; spinning the gear minimizes the spreading of the honing oil. The machining parameters are summarized in the following table (Tab. 4).

The high removal rate is primarily determined by the high delivery rate and high cutting speed. With increasing rpm, a rise in material removal is clearly noticeable (Dia. 3). The mathematical removal characteristic is determined by the feedrate, i.e., by the diametric preset diametrical honing stone feed per unit of time. The difference between calculated and measured stock removal results from feed losses caused by deflecting the components in the complete feeding system. The increasing deviation from about 1500 rpm is explained by an increase in coolant flow at increased rpm. The

CONTROL WHEEL MACHINING	
Machine Type	Rotary Indexing Machine
Spindle Configuration	Vertical
Fixture	Floating Single Part Holder
Qty. of Hone Operations	2
Tools	In-process adjustable multiple stone tools with CBN-abrasives of various grit
Machine Layout	<ul style="list-style-type: none"> <li>● Load and unload</li> <li>● Mechanical pre-gaging</li> <li>● Rough honing</li> <li>● Pneumatic post-gaging<sup>1)</sup></li> <li>● Finish honing</li> <li>● Pneumatic post-gaging</li> <li>● Spin-dry</li> </ul>

<sup>1)</sup> instead of pneumatic post-gaging, a pneumatic in-process gage can also be used.

Table 2: Layout of Honing Machines for Machining Components

GEAR WHEEL 4th GEAR	
Total Hone Allowance	≤ 0.350 mm
Cycle Time	20 s
Hone Time	18 s
Machine Utilization	120 parts/hr at 80%
Material	Forged Steel
Preparation	Turned and hardened on 680 HV30

Table 3: Required Machining Quality on a Hardened Gear Wheel

	ROUGH HONING	FINISH HONING
Qty. of Honing Stones	4 to 6 (depending on diameter)	
Cutting Material	CBN	
Grit Size	B213	B46
Bond	Sinter Metal	
Dimension	4x4x25 mm	
Cutting Speed	145 m/min	95 m/min
Feed	Electromechanical (EMZ-F)	
Allowance	0.200-0.300 mm	0.015-0.025 mm
Hone Time	Approx. 18 s	Approx. 18 s
Gage-Control	Pneumatic In-Process Gage	Pneumatic Post-Gage with Feedback Function

Table 4: Machining Parameters for Honing Gear Wheel Bores

influence of the stroke speed in the area examined is not significant. Because of the material properties and the high cutting capacity, the rough honing operation produces less finegrained hone sludge. Instead, fine, long continuous chips in the form of a steel wool ball result.

The function of CBN-abrasives of a middle concentration (stock removal £ 0.300 mm in 18 s) is decisive for the entire process. The use of low viscosity honing oil ( $h = 4.6 \text{ mm}^2/\text{s}$ ) has a positive effect on the cutting behavior and, thereby, on the consistent manufacturing quality and tool life. In addition to the constructive design of the hone tools, the condition of the abrasives is of vital importance. They are composed of a metallic binder, fused with the proper concentration of CBN-abrasive crystals (Dia. 4). Apart from the selection of binder and grain material, the sinter parameters in the manufacturing process of honing abrasives determine the quality. The hone tools are rigidly connected to the spindle. Below the part, the tool body is formed as a carbide reinforced guide shaft. The tools,

depending on design feasibility, have as many abrasives as possible. This improves machining accuracy with regard to dimensional stability and increases cutting performance and tool life.

The individual processing with conventional abrasive tools is the most economical variation of gear honing. The stationary fixtures are arranged under the two hone spindles. With the rotary index movement, the gears are loaded into the fixture. The fixture consists of the floating part holder and the zero-clearance hold-down device (Dia. 5). The part is situated on one of the flat sides of a moveable pallet. The hydrostatic friction bearing of these pallets enables effortless but not undamped movement on the flat. A torque recorder in the gear teeth has been proven effective. This occurs by means of the insertion of the gear into an integrated switch sliding sleeve or by



Diagram 2: Machining Stations for Honing Gear Wheels

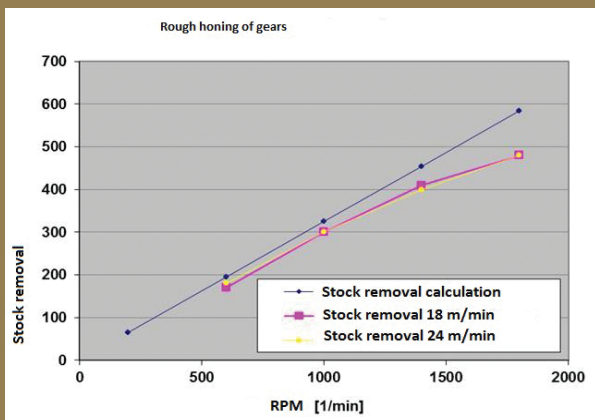

Diagram 3: Correlation of rpm and Stock Removal (Control Wheel Diameter 35x26 mm, Forged Steel, 680 HV30, Hone Time 18 s, L600 Honing Machine)

**Visit us at IMTS - Booth N-6751**

**Invest in the Value Created when You Collaborate with the BEST**

Trust is earned through a consistent, repeatable experience that adds value to your products. So, when choosing diamond powders for specialty applications, don't leave quality to chance.

Count on Engis to deliver high quality micron diamond powders with properties that are precisely defined and controlled for consistent performance in HPHT sintering of PCD products, as well as, manufacturing of precision grinding, slicing and dicing wheels (resin/metal/vitrified/electroplated bond systems), and precision lapping and polishing.

**Only Engis offers:**

- Unsurpassed expertise in diamond micronizing
- Advanced diamond micronizing process
- Unique micron diamond characterization techniques

**COMPREHENSIVE QC**

**PROCESS DEVELOPMENT**

**HPHT SINTERING OF PCD**

**PRECISION GRINDING**

**LAPPING & POLISHING**

**Trust the diamond experts at Engis.**

**Leaders in Superabrasive Finishing Systems**

**Engis**®

[www.engis.com](http://www.engis.com)

USA • JAPAN • HONG KONG • CHINA  
KOREA • CANADA • SINGAPORE • EUROPE

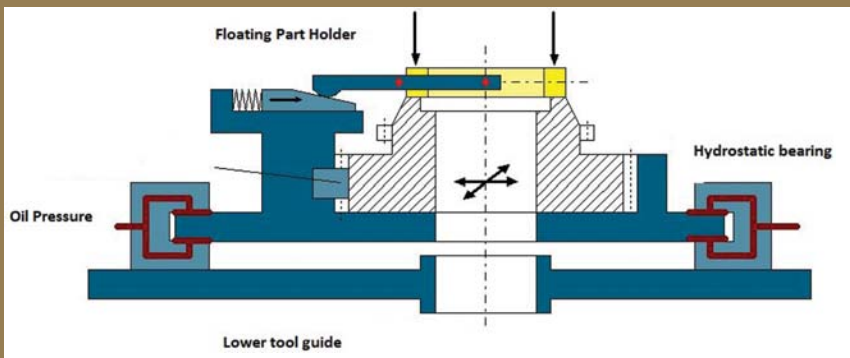

**Diagram 4: Hone Tools with Lower Guides and CBN-Abrasive Crystals (B213 / B46)**

applying a safety catch. The zero-clearance hold-down to accept the upper facing axial force helps with the deformation-free fixation of the gear. The lower guide stabilizes the tool axis to the clamping level at a right angle.

The described process design can reliably achieve the required tolerances. The roughness and the axial runout are not statistically evaluated here. With the finish hone stones (B46), the Rz-value amounts to about 1.5 – 2.5  $\mu\text{m}$  and the axial run-out precision of 15 to 25  $\mu\text{m}$  only meets about 40% to 50% of the tolerance. The cycle time achieved is 20 s with an allowance of  $\pm 0.300$  mm in the 1st operation (determined by cycle time). The quality parameters of diameter, roundness and parallelism are also calculated to meet tolerances and satisfy the statistical tolerance limits.

Measuring the compressive stress with the help of x-ray diffraction shows the condition of the material structure in the area of the marginal zone of the honed bore surface. The compressive and tensile stresses in the sub-surface are depicted. The stress in the area of the functional surface is substantially influenced by the hardening process and the stress of the finishing operation. The penetrating x-rays are reflected in the relaxed marginal zone according to the particular grid pattern of a material at a constant angle. Tensile or compressive stresses, however, imply deviations in the grid pattern from the normal value for the relaxed state, caused by the machining forces of the finish operation. They are verified by changing the reflection angle. In terms of fatigue strength, the highest possible compressive stress (-) is always advantageous.



**Diagram 5: Floating Uptake with Zero Clearance Hold-Down**

The available measurements (Dia. 6) were taken with a Stresstech XSTRESS 3000 instrument. The values were measured axially and tangentially. The hone angle of about 20° causes an uneven distribution of the compressive stresses in both directions on the honed surface. With increasing material depths, that is, with diminishing

# EXCLUSIVE IMTS SUPERABRASIVES SHOWING

STOP BY BOOTH **N7440** TO LEARN MORE

SCHEDULE YOUR PERSONAL MEETING  
E-MAIL: [IMTS@RADIAC.COM](mailto:IMTS@RADIAC.COM) | VISIT: [IMTS.COM](http://IMTS.COM)

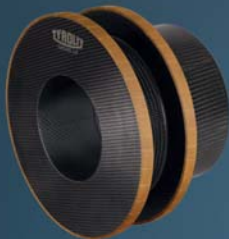

GENIS CF



GENIS

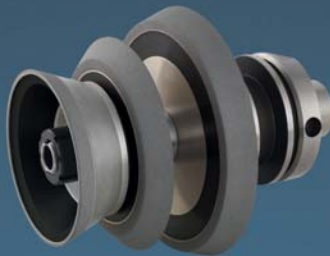

STARTEC XP-P  
HIGH PERFORMANCE  
WHEEL PACK



STARTEC PG1



STARTEC MP1





influence of the machining forces, a broad homogenization of the clamping is measurable. The achieved results indicate the advantage of the honing process. They clearly exceed the values of competitive processes such as hard turning or grinding.

### Honing Planetary Gears in Combination Machining

The combination machine with the processes of flat finishing, grinding and honing offer a new possibility for machining planetary gears, as shown here. This rotary indexing machine completes the processes on the part, one after another in one clamping. This allows various machining geometries, such as one bore and one face surface to be machined, each with tight tolerances relative to the other. The compact machine workspace essentially consists of a circular rotary table, on which the rotary driven units are constructed and the central column, where the machining units are assembled to the upright surfaces. The result is a self-sufficient machine with a small footprint and short transport route in the indexing of the part. The circular rotary tables make the machining units easily accessible for maintenance work and tool changes.

Diagram 7 depicts the process steps for such combination machining. The part is only pre-machined on the front and in the bore. The gear wheel is located in the fixture with an unfinished side up and is clamped radially on the gear teeth. The tip diameter or the involute teeth are the geometric identifying elements for the position of the part. The upper front is machined by flat finishing 1. Then, the part is turned, so that the previously finish-machined end surface fits in the fixture as the locating surface. In the subsequent grinding operation, the bore is ID ground centric to the gear teeth. With this, the desired radial run-out tolerance is

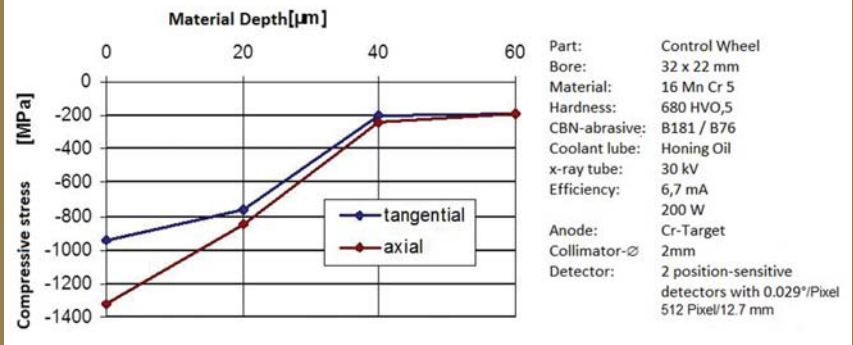

Diagram 6: Progression of Compressive Stress with Increasing Material Depth

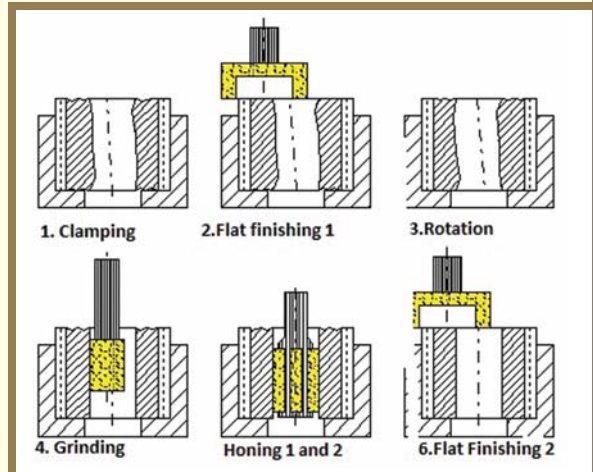

Diagram 7: Process Steps for Combination Machining



## Specializing in Electroplated and Brazed Diamond Tooling

- ▲ Diamond Band Saw Blades
- ▲ Diamond Circular Saw Blades
- ▲ Diamond Hole Saws
- ▲ Diamond Wheels
- ▲ Custom Tooling

[www.niabraze.com](http://www.niabraze.com)

675 Ensminger Road

Tonawanda, NY 14150

716.447.1062

THE COMPETITIVE EDGE  
in superabrasive products



Diagram 8: Machining Stations for Machining Planetary Gears

unload station in the left-hand photo. In the right-hand photo, the grinding spindle directly before plunging in the part is depicted. The middle photo shows the honing stations arranged after grinding, as well as the gage station for measuring the diameter after honing. All stations together work the rotary driven part. This is especially unusual in a hone process, but allows a significantly simplified spindle set-up. The hone tool only performs a feeding movement and a stroke movement. The machine concept is designed such that other process sequences are configurable. There is also the opportunity to integrate modified modular units such as deburring, wheel dressers, belt finishing or reaming. The concept of combined machining is especially useful in the manufacturing of planetary gears. Previously, the manufacturing processes for flat finishing, ID grinding and honing required different machines. The consolidation of the processes into one machine allows high capital investment savings, increased productivity and reduced operational footprint. (Dia. 9). For planetary gears, cycle times of 7 s with material removal in the bore of  $\leq 0.15$  mm are achieved. ●



Diagram 9: Machine for Combination Machining of Gears

achieved. This enables the subsequent station to work with a tightly clamped hone tool because the alignment is made to the unchanged clamping fixture and guarantees the centric ground bore. Therefore, a new bore axis will not be partially processed. The hone process consists of a rough hone and finish hone operation. Between the two hone operations is a gage station, in which a plug gage records the rough hone diameter using the principle of pneumatic length measurement. After finish honing, the flat finishing 2 takes place. Here, the second end face is machined parallel to the first end face.

Diagram 8 shows the individual machining stations, with the flat finish machining directly after the load and

Designer and Manufacturer of Quality Machine Tools Since 1974

# DCM

## ROTARY GRINDERS

**WHERE  
THE FACE OF  
PRECISION  
BEGINS**



DCM got the **Point** years ago when designing the "SD" series rotary grinders. Variable spindle RPM, table speeds, and feedrates can be optimized for Diamond & CBN abrasives. Programable parameters can be saved for repeatable performance in lab or production applications.

With over 30 years of machine design and manufacturing experience, DCM Tech builds a line of industrial grinders for a variety of applications. DCM grinders offer fast, close tolerance performance whether grinding metal, glass, carbide or ceramic. Innovative control packages provide process automation and repeatability. Integral mist collection and coolant filtration systems enhance grinding performance as well as shop cleanliness and operating conditions.



DCM TECH  
4455 Theurer Blvd.  
Winona, MN 55987

INTEREST@DCM-TECH.COM

1-800-533-5339

www.dcm-tech.com



# WHAT YOU NEED TO KNOW ABOUT SOCIAL MEDIA ETIQUETTE

*By Margaret Page*

Like children with a shiny new toy, adults introduced to social media jumped in and started playing: posting personal photos, accepting requests for “friendship” from long-lost high school pals, and checking in everywhere from the coffee shop to their favorite local eatery. What fun! Suddenly we were getting an inside look into the lives of people we hadn’t connected with in years! Social media didn’t come with any real instructions. We unwrapped it, signed up and off we went, sharing with the world, the seeds of chaos were planted.

## RULES OF ENGAGEMENT

Without guidelines, disaster is just a tweet away. Many people have found this out the hard way. Embarrassing gaffs, impulsive rants, and misguided comments have ensued. What you post on social media sites is out there forever. A “selfie” posted after a night on the town or a tweet about a colleague can cause more damage than you think. All it takes is for one of your friends to share it with their friends. And what you say CAN and WILL be held against you! Your future boss, clients, partners, voters and vendor are watching. With so many companies supporting BYOD, it’s more important than ever that a clear social media policy is in place for employees. Your employees are representatives of your brand, and in business, perception is everything. To protect yourself from the embarrassment of a social media faux pas, create a policy that clearly states what you expect from your employees on social media.

## DO I KNOW YOU?

With our ability to connect to anyone, anytime, through social media, the term “connected” has been watered down. How many of the generic “I’d like to add you to my professional network on LinkedIn” do you receive each month? Very few of them are from people you have truly “connected” with outside of social media. Before there was LinkedIn, you wouldn’t dream of asking a new acquaintance to buy something from you just minutes after you met. Just like offline networking, building relationships online, follows the same basic etiquette rules.

- **BE PROFESSIONAL.** Post a professional photo of yourself on your profile. This holds true on all social media sites. A business colleague should recognize you from your online picture. Include information about yourself. Your social media profiles are the equivalent of your business card, so be sure you keep it updated.
- **INTRODUCE YOURSELF.** Want people to get a sense for who you are? Post interesting, value-added content on your social media accounts to showcase your professional expertise. This is especially true with LinkedIn; when you update your status with useful information, you’re building trust among your network.
- **BE AUTHENTIC.** Just like in real life, no one wants to connect with “that guy.” You know the one: the guy in the sleazy suit who spends his time schmoozing. One of the biggest mistakes people make when connecting on LinkedIn or Facebook is not personalizing the message in the invitation. Swap out the default message with something like “George. I really enjoy your blog at xblog.com. The leadership content you share is so valuable. I’d like to add you to my professional network and get to know more about your business.” This will let the recipient know how you found them and why you want to connect.
- **LISTEN.** Building connections through social media isn’t just about pushing out content on this network or that. If you’re not taking time to listen and engage with influential people (the ones you are hoping to connect with), you’re missing an opportunity.

Whether you are connecting with people in the online world, or at a dinner party, knowing how to present yourself in a positive way is the same. Think before you speak translates to “think before you tweet.”

### ABOUT THE AUTHOR

**MARGARET PAGE** is a recognized etiquette expert, speaker and coach, who helps people and organizations be more professional. She is the author of *The Power of Polite*, *Blueprint for Success* and *Cognito Cards — Wisdom for Dining & Social Etiquette*. She is the founder and CEO of *Etiquette Page Enterprises*, a leading Western Canadian training organization. To contact Margaret, please visit her website at <http://etiquettepage.com/>, or call 604 880 8002.

# United States Manufacturers Reboot: Three Initiatives for Success

By CHRISTINE H. LUZAR  
Market & Technology Research Consultant

## Why?

There is no agreed upon list of all causes, however, the following three reasons are most often cited as triggers for redefining how and where works gets done:

1. Recalculating the true cost of off-shoring TCO (Total Cost of Ownership) calculations have led US manufacturers to question the belief that off-shoring production--particularly to Asia—is the most effective response to global competition. When the true cost of offshoring (delays due to miscommunication, thousand mile freight runs and slow reaction times to fast changing market conditions) are added to scrap and rework costs, the actual cost advantage of offshoring is significantly reduced. A study released by MIT (US Re-shoring: A Turning Point, January, 2014) reports 33.6% of respondents are "considering" bringing manufacturing back to the US, 15.3 % of U.S. companies are "definitively" planning to re-shore activities.
2. Lack of skilled workers in the US Returning manufacturing capacity to the US has its own set of problems. With skilled tradesmen already in short supply, added to the projection of a record number of retiring workers, one of the top priorities for manufacturers will be to explore new avenues of automated production.
3. Speed to market/Accelerated competitive response The ability to commercialize ideas quickly is critical to defending market share as products continue to see shortened life cycles. Process innovation is pursued to compress time-to-market, react to market/competitive change, and wring profitability from short life cycles.

Leading manufacturers' internalize and respond to these three factors, redesigning processes to be progressively: SMART, GLOBAL & SUSTAINABLE

## SMART

When leading manufacturers redesign processes to be "SMART", they integrate robotics selectively. CNC is still the standard automation response, but robots are increasingly deployed. Improvements in the rigidity of end-of-arm tooling (EOAT) has specifically opened the door to deploy robots using diamond coated or diamond tipped tools for secondary processing (drilling and routing) of formed composite parts.

Using latest generation robots, manufacturers gain both the benefits of robotic automation (increased feed rate speed, accuracy and flexibility in manufacturing cells) and the wear resistance of diamond tooling.

Interestingly, robotic automation is advancing more quickly in US Tier 1 and Tier 2 component suppliers. Historically, robot automation has not been an option for short-runs or high-mix lines. Robot automation in these applications has been either too costly or complex to consider. Two recent technical developments may create a game-changing environment for medium and low volume runs.

**"ROBOT IN A BOX/COLLABORATIVE ROBOTS"**

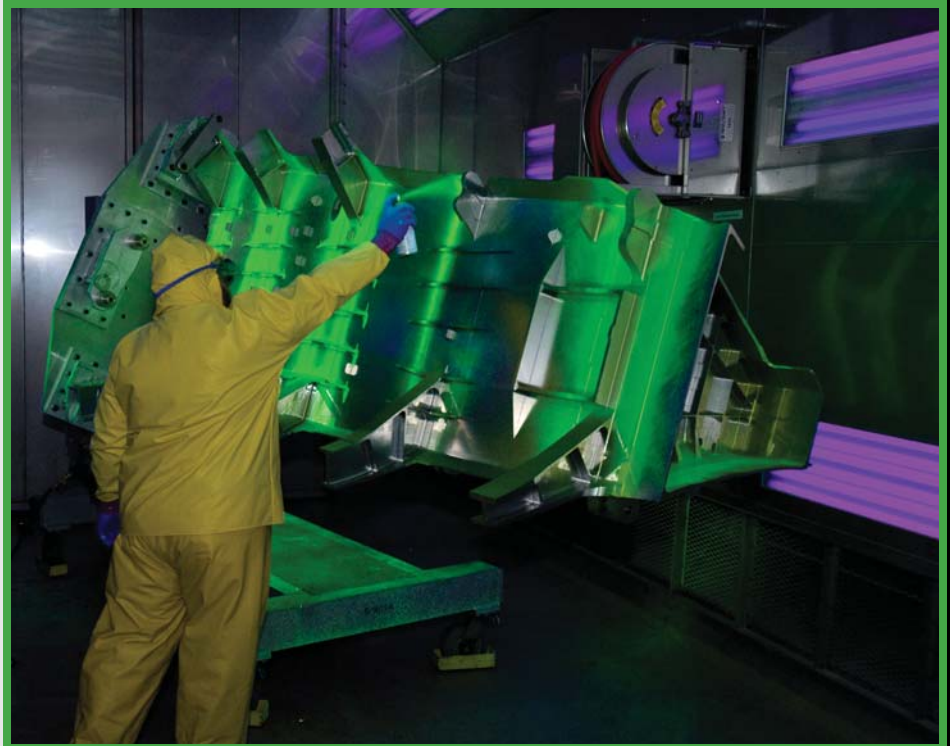

*Photo of Aircraft Carbon Composite Component courtesy of The Boeing Company*

## OVERVIEW

With economic indicators painting an ambiguous near-term outlook, many US manufacturers question the timing and feasibility of new capital investment and hiring. Key takeaways from projects completed in the last six months suggest the pressure to reduce expenses and find new efficiencies cannot be ignored, but US manufacturers who rely solely on unit cost and doing more with less may be left behind. In order to spur growth/productivity, findings indicate that leading US manufacturers are moving beyond the process standards of Deming, Six Sigma and LEAN manufacturing.



**Figure 1: Diamond Coated Drill F-35 Composite**  
 Courtesy: Amamco Tooling



**Figure 2: Diamond Router for Composite Edging/Trimming**  
 Courtesy: Sandvik Coromant



**Figure 3: Universal Robot**



**Figure 4: Rethink Robot**

A new class of robots has emerged (2012-2013). They work directly alongside employees with no safety caging and are designed to bridge the gap between manual assembly and hard automation. Co-robots in Figures 1 and 2 are easily moved and reprogrammed to solve new tasks, meeting short-run production challenges.

### PLUG AND PLAY CAPABILITY

Robots with re-designed interfaces eliminate the need for in-depth programming and extensive engineering line support. Robot Manufacturer Yaskawa Motoman, for example, introduced Kinetiq Teaching (Q3 2013) a control box for programming the motions of a robot that makes setup of robotic welding robots “as easy as playing candy crush”.

Kinetiq Teaching simplifies setup so machinists and welders can adjust welding parameters on-the-fly; it becomes as fast to weld 6 brackets with a robot as it is to weld them by hand.

## Global

**Leading manufacturers redefine not only how, but where work gets done.**

For leading US manufacturers, regional operations are the strategic response to creating value on a global basis. Leaders embrace a regional manufacturing strategy to drive delivery of quality products, on time, at a global price. “Next-Shoring: A CEO’s Guide” by Katy George, Sree Ramaswamy and Lou Rassey published in the McKinsey Quarterly January, 2014 defines this shift to strategic regional manufacturing as “next shoring”. “Next-shoring isn’t about the shift of manufacturing from one place to another but about adapting to, and preparing for, the changing nature of manufacturing everywhere.” McKinsey discussions with leading manufacturers highlight:

1. In order to capture demand in both mature and emerging markets, it is important to manufacture in facilities that are close to both.
2. The ability to respond to individual market needs is critical--not the ability to produce where labor cost is lowest.

## Sustainable

**Leading manufacturers have found running a company to create profit and to simultaneously address its environmental impact, saves hundreds of millions of dollars and grows market share.**

To drive profitability and sustainability, leading manufacturers embed Sustainability into the fabric of the organization, not bolt it on. Leaders create a plan, put programs in place to achieve it, rigorously measure it, and publicize results. Experienced change-makers within the organization champion the process. Leaders describe the path to sustainability as a 3 phase process:

### PHASE 1: Tie Sustainability to Tangibles

Energy Efficiency is the galvanizing low hanging fruit of Sustainability. In Phase 1, fundamental programs to reduce energy/water consumption, recycle, and minimize waste drive a Sustainability mentality. Performance is visible, widely reported, ranked, and rated.

### PHASE 2: Gain Traction, Scale up

Leaders commit to energy efficiency in Phase 1; when goals are met they declare victory and announce bolder goals and broaden the reach of Sustainability. In Phase 2, the supply chain is integrated into the organization’s sustainability program (Tier 1 suppliers are an extensions of ourselves). External advisory boards are formed to challenge the initiative beyond fundamentals--outreach priorities are agreed upon and results measured.

### PHASE 3: Lead and Influence

In Phase 3 the mindset shifts from “doing less bad” to building a differentiator. Sustainability directs what leaders think and do--how they: Innovate, Collaborate within and outside the organization and Build competitive advantage

*Sustainability has momentum. It’s in the products we make and how we make them, in every plant and supplier relationship around the world.*

## Table 1: Excerpt 2013 GE Annual Report

*GE's investments in our Rutland, Vermont Aviation plant have created manufacturing possibilities as advanced as our engines. The Rutland team partnered with GE's Global Research Center on specialized tools (robotic arm manipulates solid carbide drill bits with a diamond coating) to shape advanced materials such as titanium and aluminide. A \$75million investment in Rutland's expansion led to more than \$300million in engine production savings.*

CSR Hub®, the world's largest corporate social responsibility (CSR) ratings and sustainability information database, indicates less than 1% of 8900 global manufacturers monitored have achieved all three levels, to net positive environmental and social impact. Leaders in US manufacturing must move beyond the process standards of Deming, Six Sigma, and LEAN manufacturing. Driving SMART, GLOBAL and SUSTAINABLE initiatives, visionary leaders recognize the need for continuous innovation.

### END NOTES

The author acknowledges the significant contributors to this article:

**CHRIS ANDERSON**, Associate Chief Engineer, Yaskawa Motoman Robotics

**BILL BAILEY**, Engineering Fellow, Du Pont Leader of the DuPont Engineering's Energy Center of Competency

**ERIC FOELLMER**, Manager of Product Marketing and Marketing Communications Rethink Robotics

**ANDREW GILPIN**, Business Development Manager, Amamco Tooling

**KEVIN HAGEN**, Director Corporate Responsibility, Iron Mountain

**ENGELINA JASPERS**, Marketing Executive and Sustainability Leader, FlexMarketing Pro, Formerly Vice President Environmental Sustainability, HP

**ED MULLEN**, National Sales Manager North America, Universal Robots

**LINN WINN**, Industry Specialist Composites Market area: Americas, Sandvik Coromant

### Special thanks to ANN DEBELACK

With 20 years dedicated to operations excellence, Ann H. Debelack has experience in a wide variety of settings including, sales, marketing, sourcing, engineering, education, translations and quality. Working for and with Fortune 500 companies, she is a proven leader in optimizing operations processes.

### ABOUT THE AUTHOR

**CHRISTINE H. LUZAR** is an independent market and technology research consultant in business 20 years. She provides clients with fact-driven research, objective analysis, and strategic advisory services. Areas of Expertise: New Venture Analysis, 360o VOC Field Research, Opportunity Assessments. Contact Christine Luzar at cluzar@frohmanassociates.com

## Finer Points

### CHECKLIST OF THINGS TO DO

- Renew my subscription to Finer Points magazine.
- Reserve my ad space in the next Finer Points issue.
- Submit article for consideration in future Finer Points issue.
- Send Finer Points my business news, new products, new hires, promotions, industry news and other press release items.
- Send in my membership application to the IDA.
- Refer a company to IDA for consideration as a member.
- Visit the IDA Website at: [www.superabrasives.org](http://www.superabrasives.org).
- Contact an IDA member for products or services.



# We are not alone.

There's a wonderful world around us. Full of fascinating places. Interesting people. Amazing cultures. Important challenges. But sadly, our kids are not getting the chance to learn about their world. When surveys show that half of America's youth cannot locate India or Iraq on a map, then we have to wonder what they do know about their world.

That's why we created [MyWonderfulWorld.org](http://MyWonderfulWorld.org). It's part of a free National Geographic-led campaign to give your kids the power of global knowledge. Go there today and help them succeed tomorrow. Start with our free parent and teacher action kits.

And let your kids begin the adventure of a lifetime.

**It's a wonderful world. Explore!**



[MyWonderfulWorld.org](http://MyWonderfulWorld.org)

A National Geographic-led campaign

# WWSA LAUNCHES NEW SOLIDS WEBSITE



[WWW.WORLDWIDESOLIDS.COM](http://WWW.WORLDWIDESOLIDS.COM)

Worldwide Solids LLC, a division of Worldwide Superabrasives LLC, proudly announces the launch of their new website found at [www.worldwidesolids.com](http://www.worldwidesolids.com). The new Worldwide Solids website enables end users to download our PCD/PCBN/CVD product catalogs and highlights our product characterization and quality control laboratory which includes a D9600 Sonoscan, JOEL SEM with EDS and Keyence VHX 2000 Digital 3D Microscope.

WWSA will continue to add product updates such as side by side product comparisons, new product developments and company news. With this new website, be the first to read about our existing and new innovations.

Worldwide Solids, LLC Headquarters  
2921 NW Commerce Park Dr., Boynton Beach FL 33426  
Tel. 954-828-9650 | [info@worldwidesa.com](mailto:info@worldwidesa.com) | [wwsa.com](http://wwsa.com)

Worldwide Solids, LLC Sales Office  
470 Olde Worthington Rd. Suite 200, Westerville, OH 43082  
Tel. 614-410-6695 | [sales@worldwidesolids.com](mailto:sales@worldwidesolids.com) | [worldwidesolids.com](http://worldwidesolids.com)

# ABN900 For precision grinding automotive and aerospace components



ABN900 is a high-performance grinding material for electroplated applications. It removes material faster with lower grinding forces than previously available grits because it has exceptional high strength, uniformity and a consistent blocky shape. This delivers durability that helps tools to work harder and extends tool life by as much as 55%\*. ABN900 is designed for precision grinding hardened ferrous metals and superalloys especially in the automotive and aerospace industries.

Find out more by visiting our website or contact Element Six directly.

\* Grinding tests conducted by Element Six with ABN900 50/60 US Mesh show the potential for extending tool life by up to 35%. Tests using ABN900 120/140 US Mesh show the potential for extending tool life by up to 55%. Contact Element Six for details of these tests, product samples and results.



elementsix™

Element Six US Corporation,  
35 West 45th St., New York, NY 10036, USA  
Tel: +1 (212) 869 5155  
Fax: +1 (212) 764 0349  
Email: [usadvancedmaterials@e6.com](mailto:usadvancedmaterials@e6.com)  
[www.e6.com/ABN900](http://www.e6.com/ABN900)